

DUAL POLARIZATION

Mitigation of Ambiguities in Range
and Velocity

Clutter Filtering

Processing of Single Polarization Signals

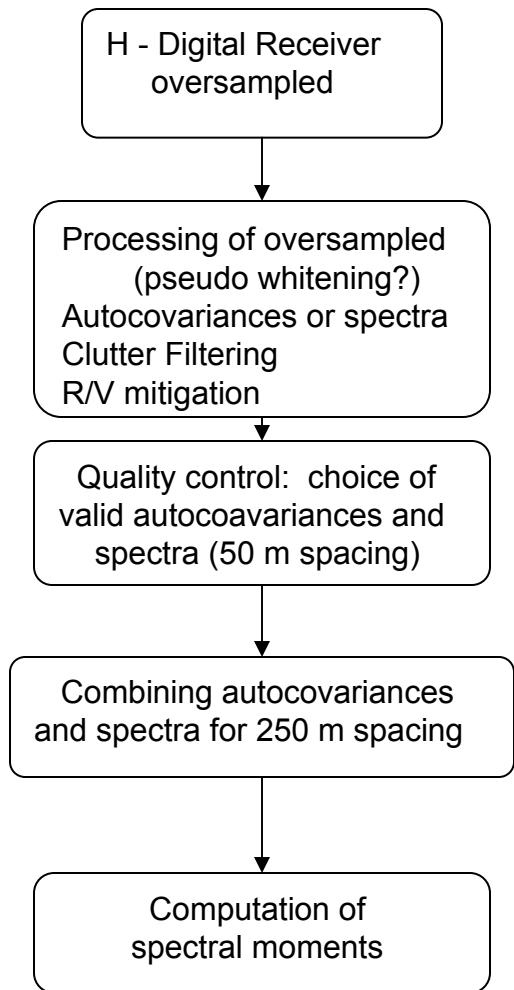

Processing of Dual Polarization Signals

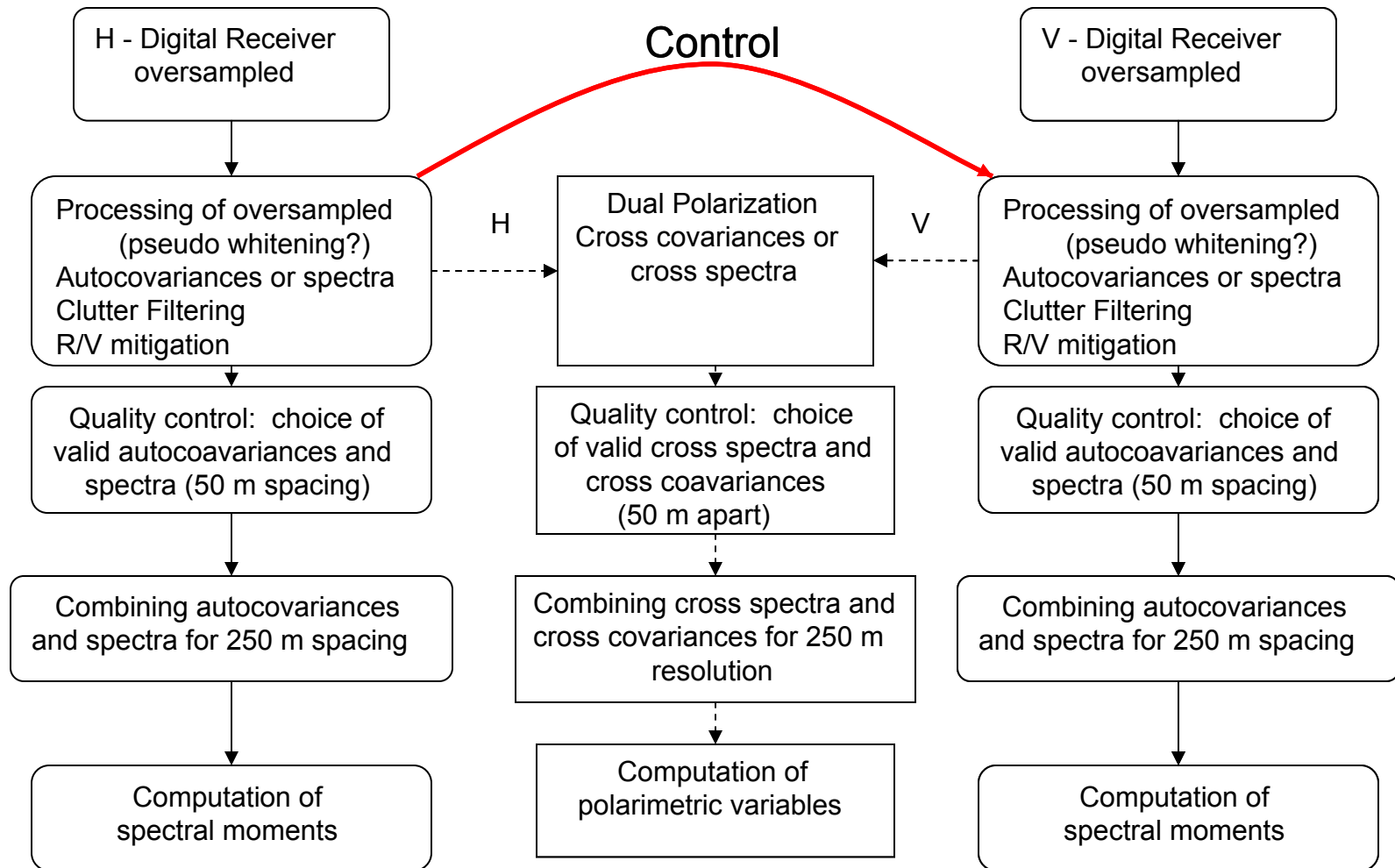

Mitigation of Ambiguities in Range and Velocity

- Phase Coding (SZ-2)
 - Surveillance Scan
 - Standard Processing to obtain Polarimetric Variables as demonstrated in JPOLE
 - Clutter Filtering – Filters must be identical in H and V channels. Trivial modification of GMAP then Spectral processing to obtain Polarimetric variables
 - Doppler Scan
 - Overlaid echoes: Spectral processing of the weaker signal
 - No overlay: Processing of Auto and Cross-covariances to obtain Polarimetric variables
 - Clutter Filtering – Filters must be identical in H and V channels. Trivial modification of GMAP then Spectral Processing

Use of the GMAP

- For Reflectivity in H channel use GMAP as is
- For v and σ_v use the same GMAP filter in both channels or same notches?
- For the polarimetric variables use GMAP on the H channel to select the notch width. Then use the same notch on both H and V channels. Do not interpolate across the notch

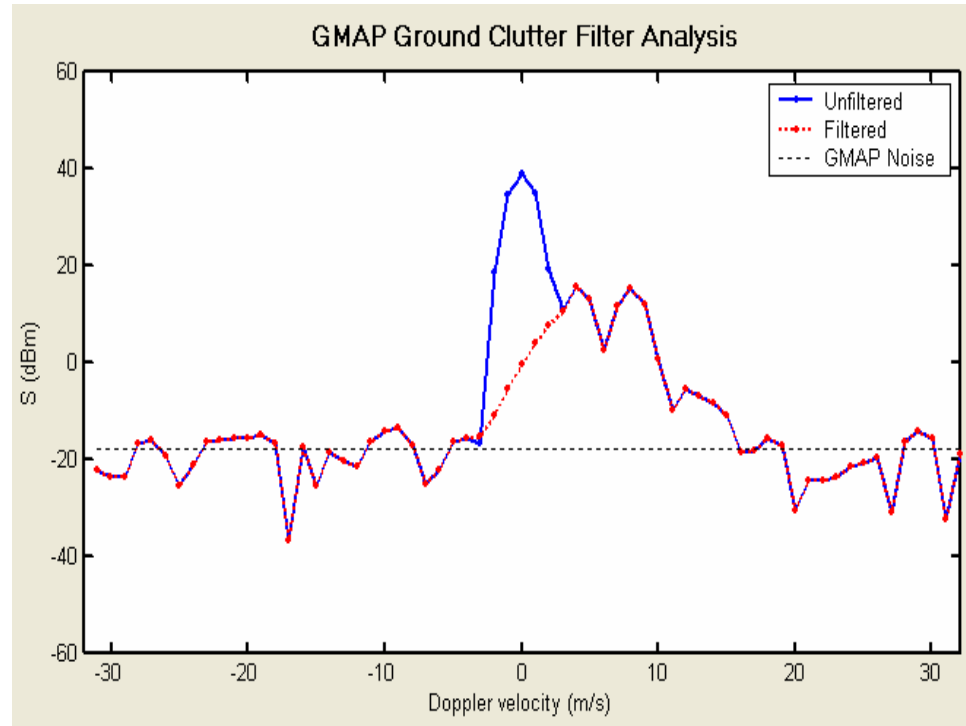

The Systematic Phase Coding Technique

- Transmitted pulses are phase-encoded with SZ(8/64) switching code

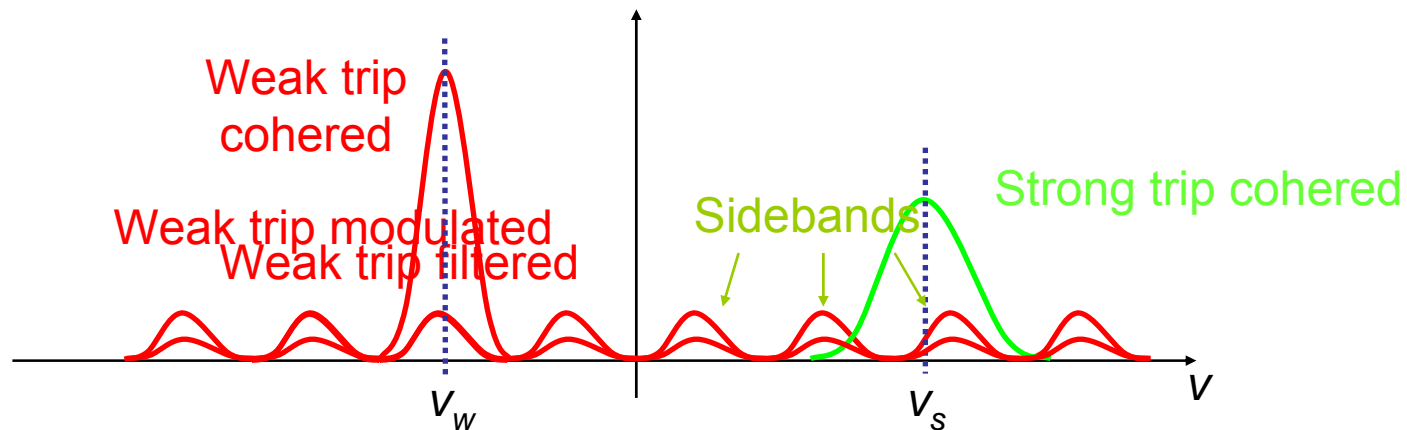

- Recovery of the weak-trip velocity is not always possible
- Phase-coded scan can be preceded by long-PRT scan

Mitigation of Ambiguities in Range and Velocity

- Staggered PRT

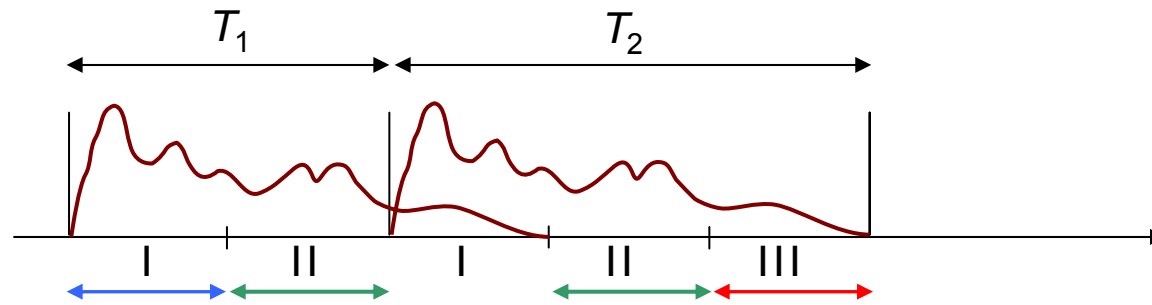

- Processing in the long PRT interval T_2 region III
 - Standard Processing to obtain Z and Polarimetric Variables

Mitigation of Ambiguities in Range and Velocity

- Staggered PRT

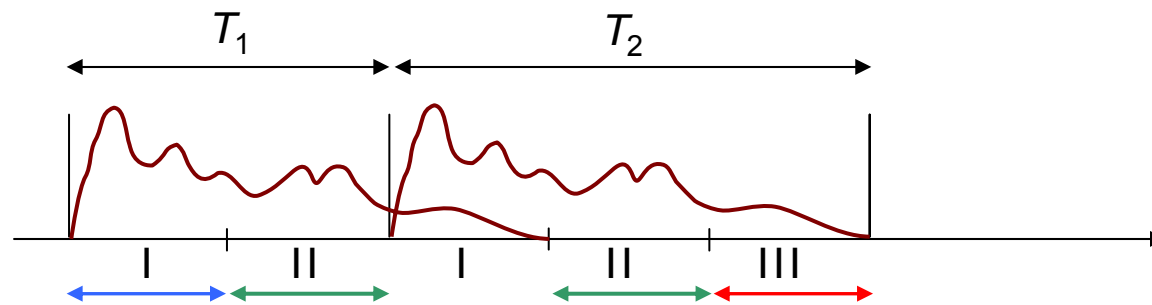

- Processing samples in regions I and II of T_1 & T_2
 - Either standard or autocovariance estimates to obtain polarimetric variables
 - Clutter Filtering
 - Use GMAP to identify clutter spectrum
 - Sachi's filter to remove clutter
 - Spectral processing to obtain Polarimetric variables

Spectrum: Staggered PRT Clutter and Signal

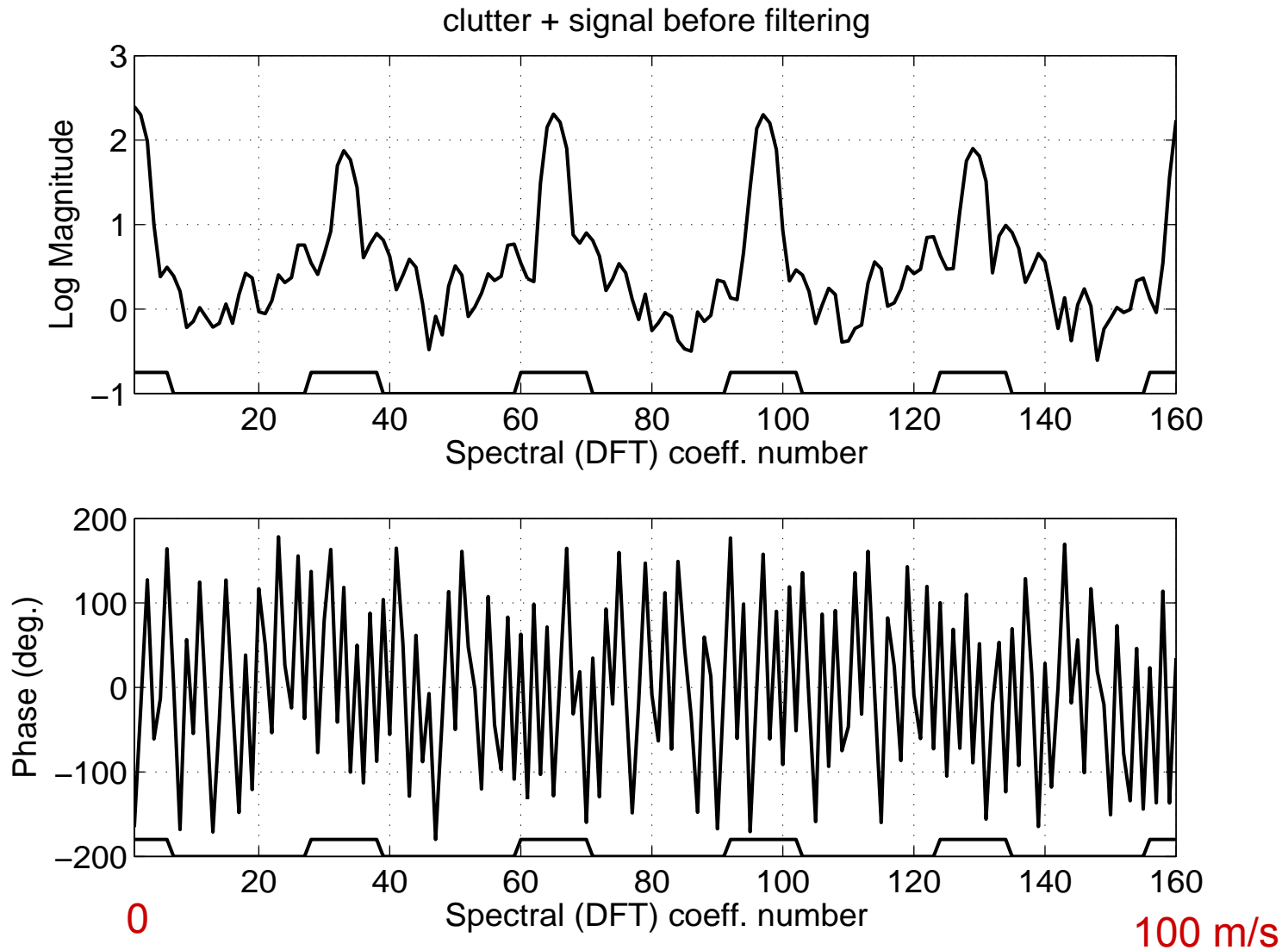

Spectrum: Staggered PRT Signal Spectrum after Filtering Clutter

Phase recovery approach – 2

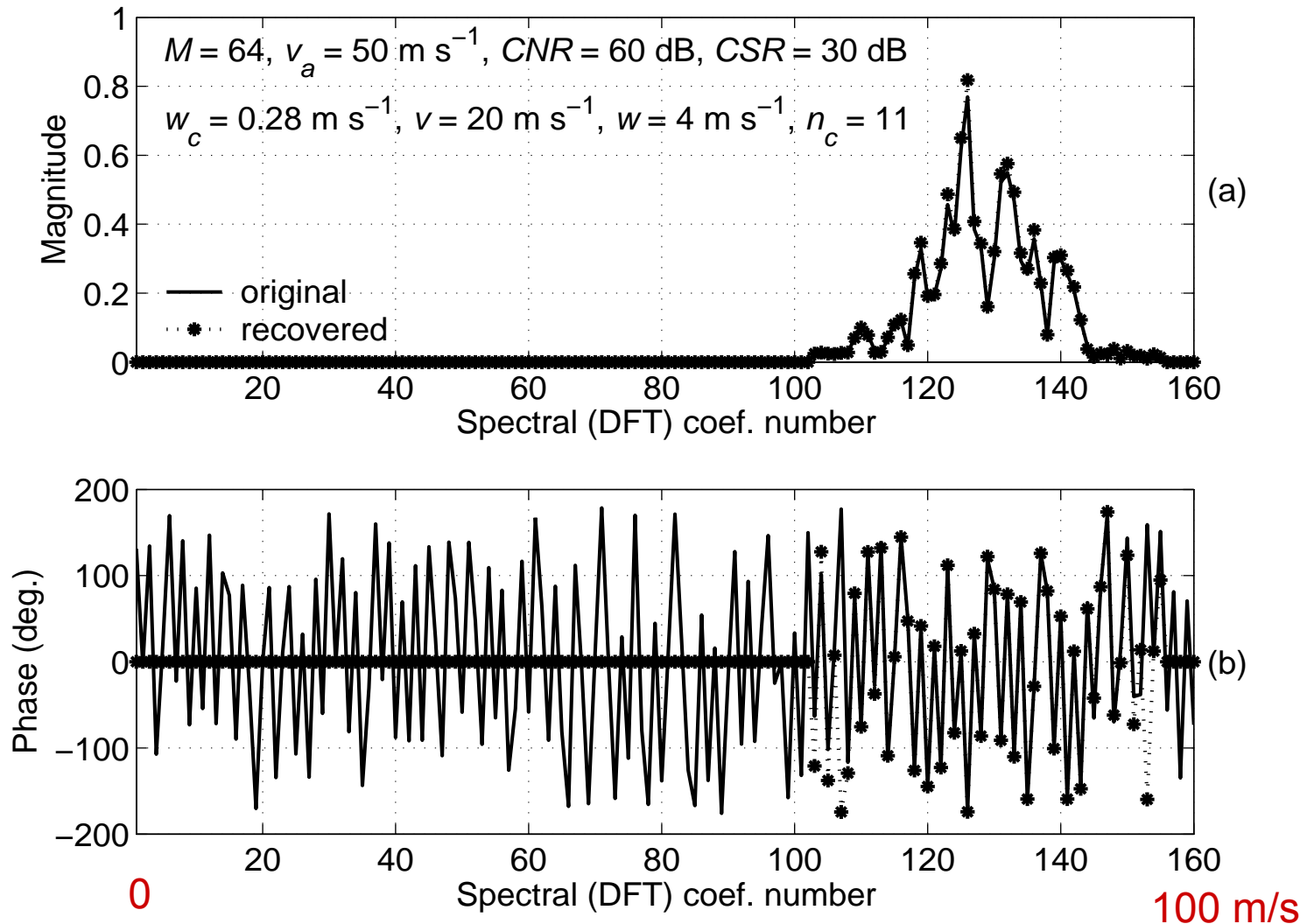

Clutter Filter Map

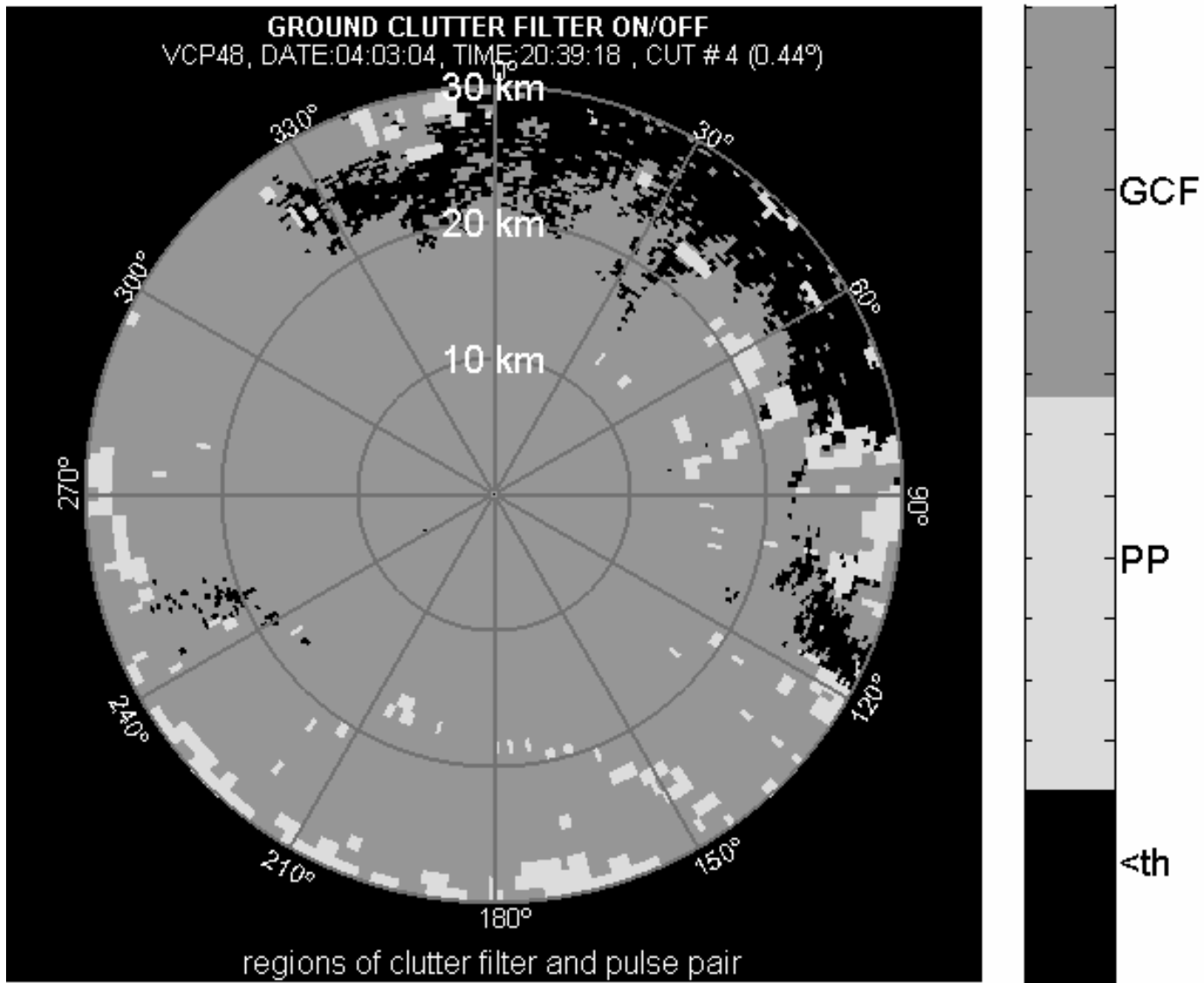

Reflectivity Field no GCF (Stag. PRT)

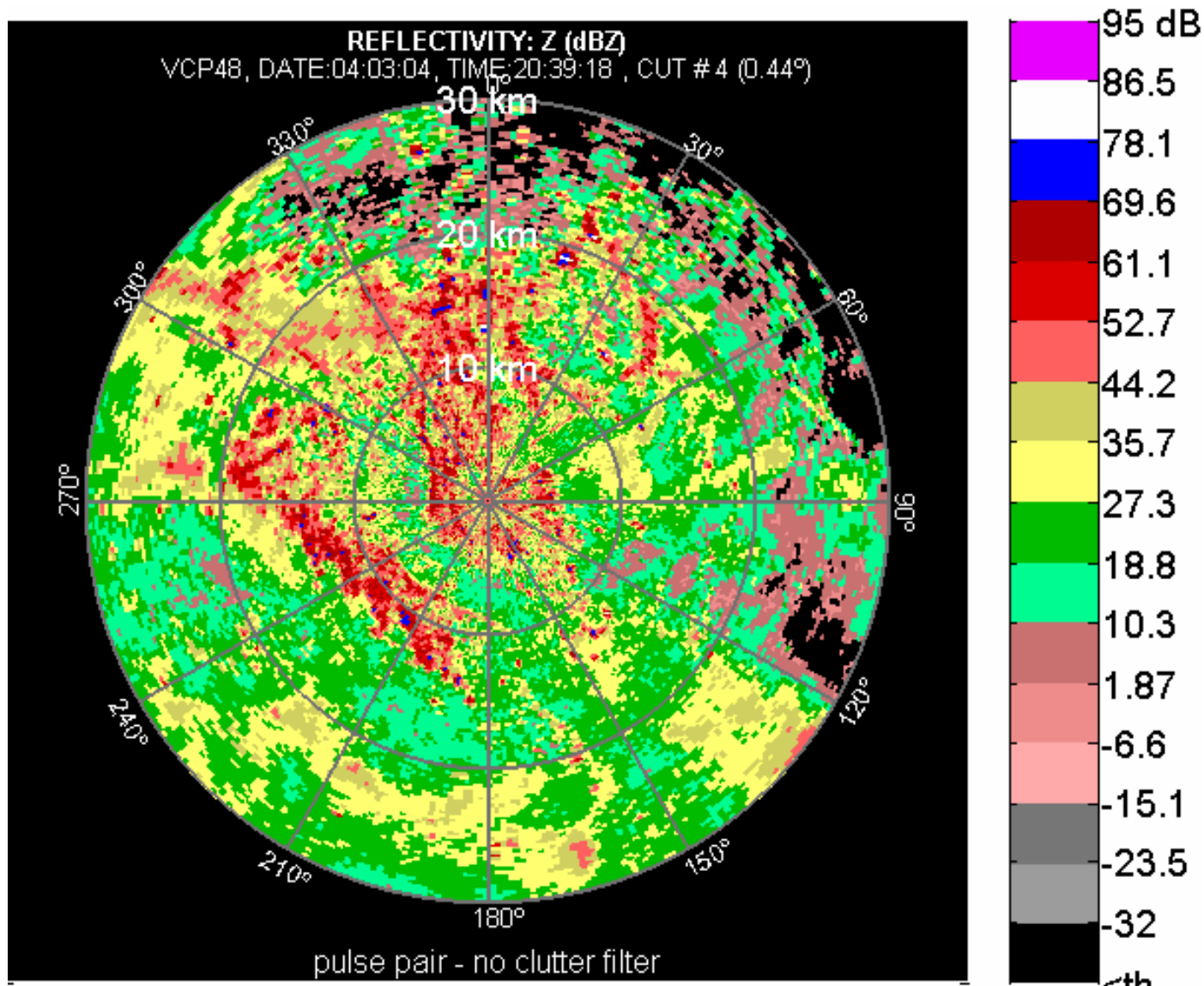

Reflectivity Filed after GCF (Stag. PRT)

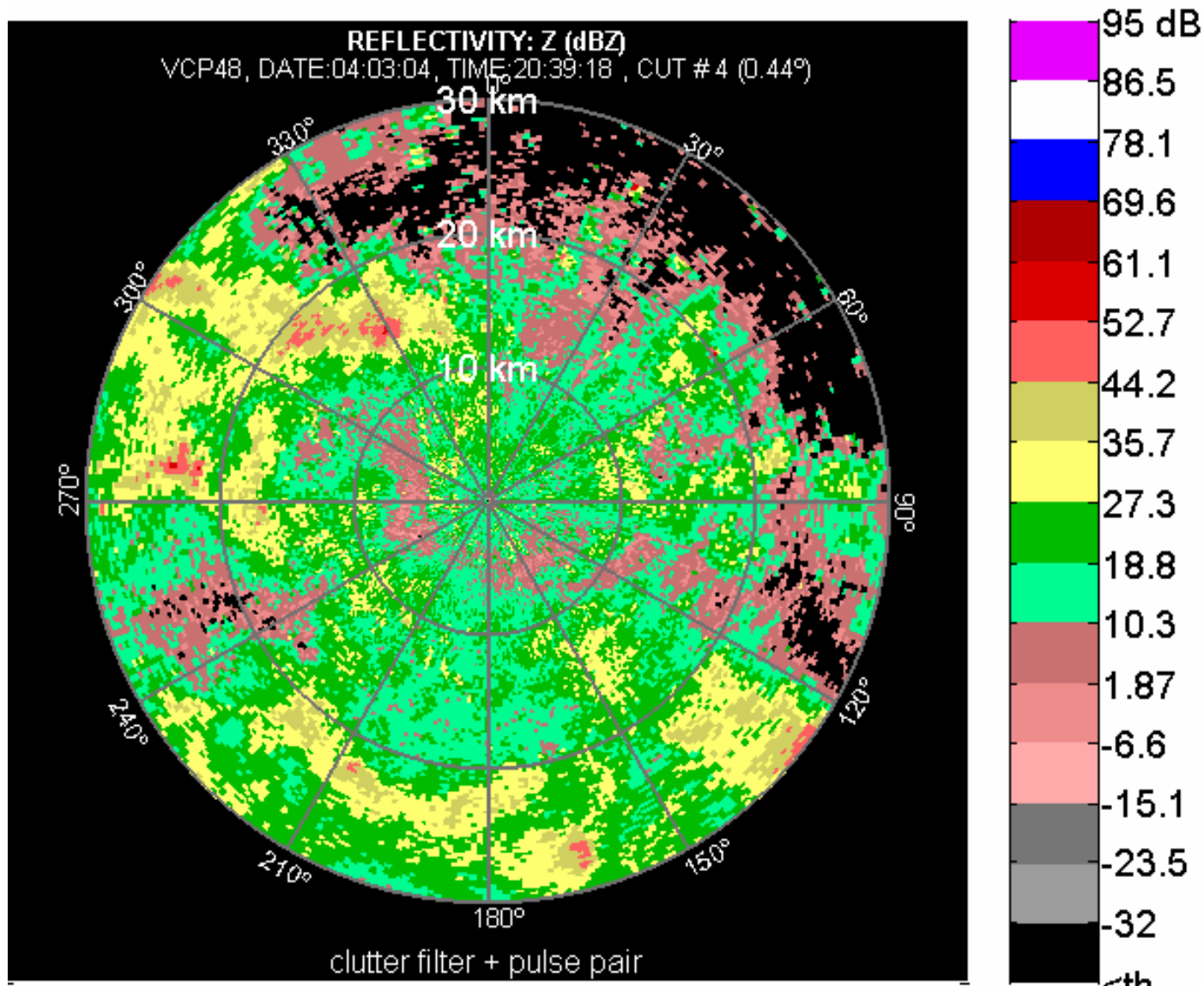

Staggered PRT GCF Suppression

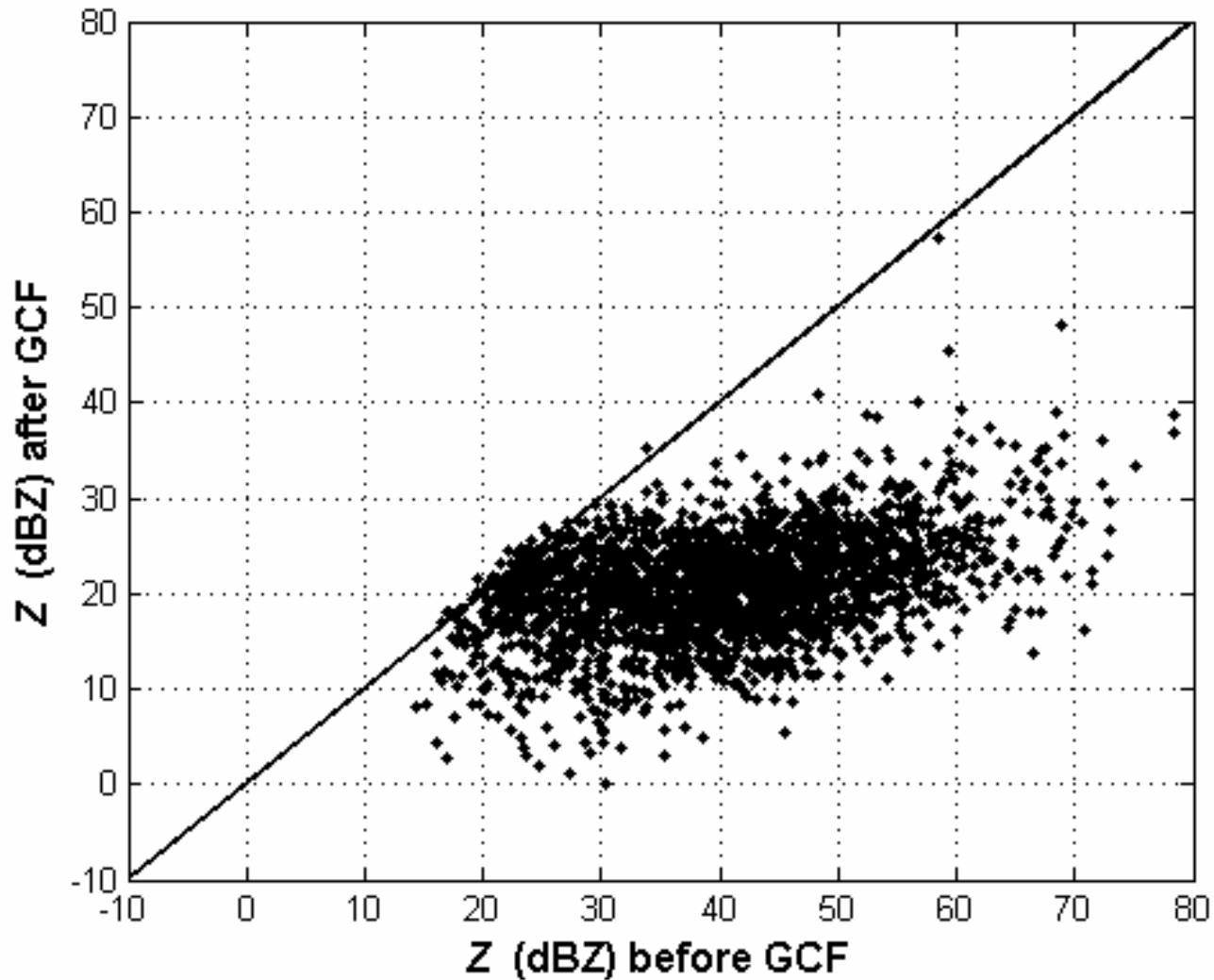

Velocity Field no GCF (Stag. PRT)

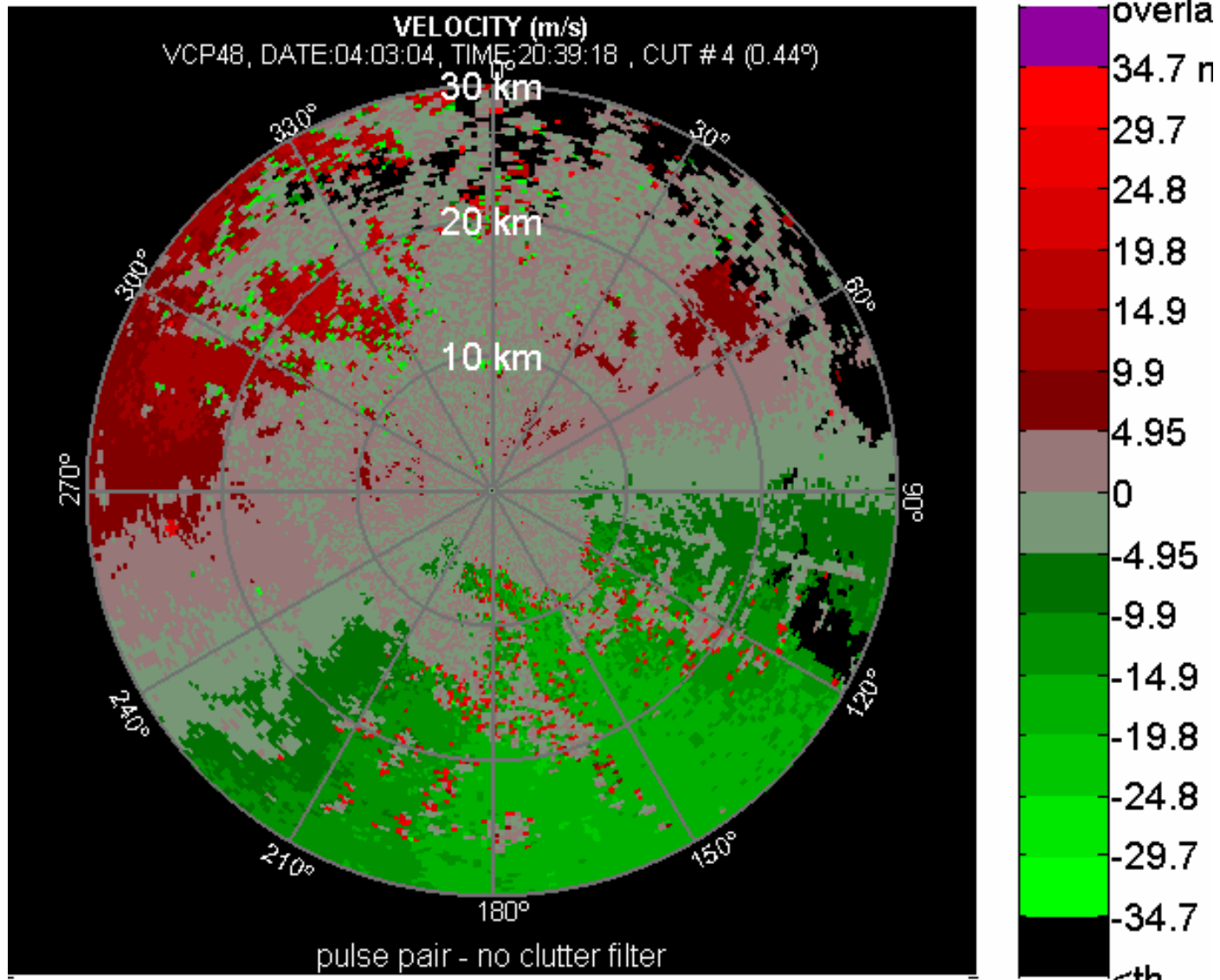

Velocity Field after GCF (Stag. PRT)

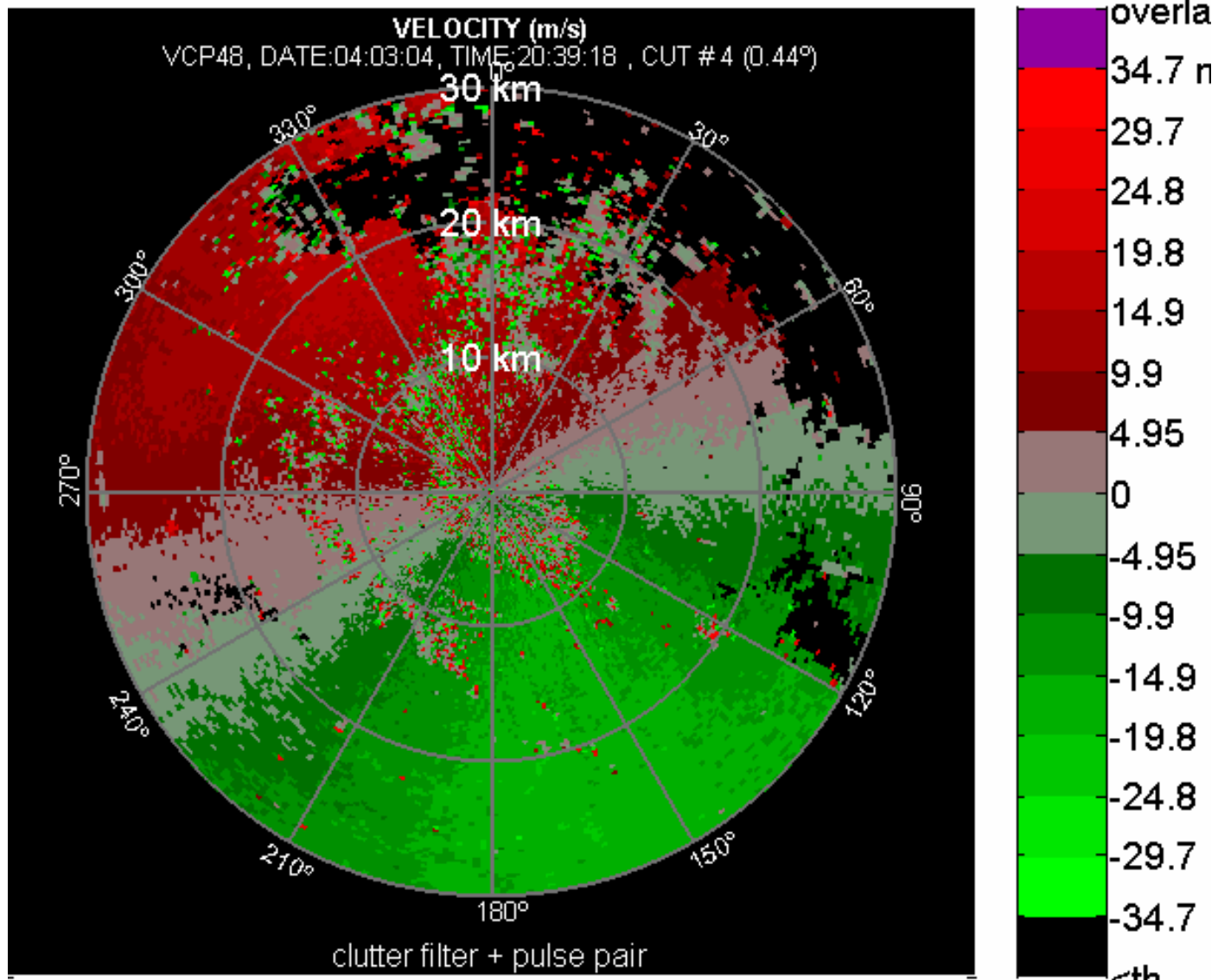

Spectrum Width no GCF (Stag. PRT)

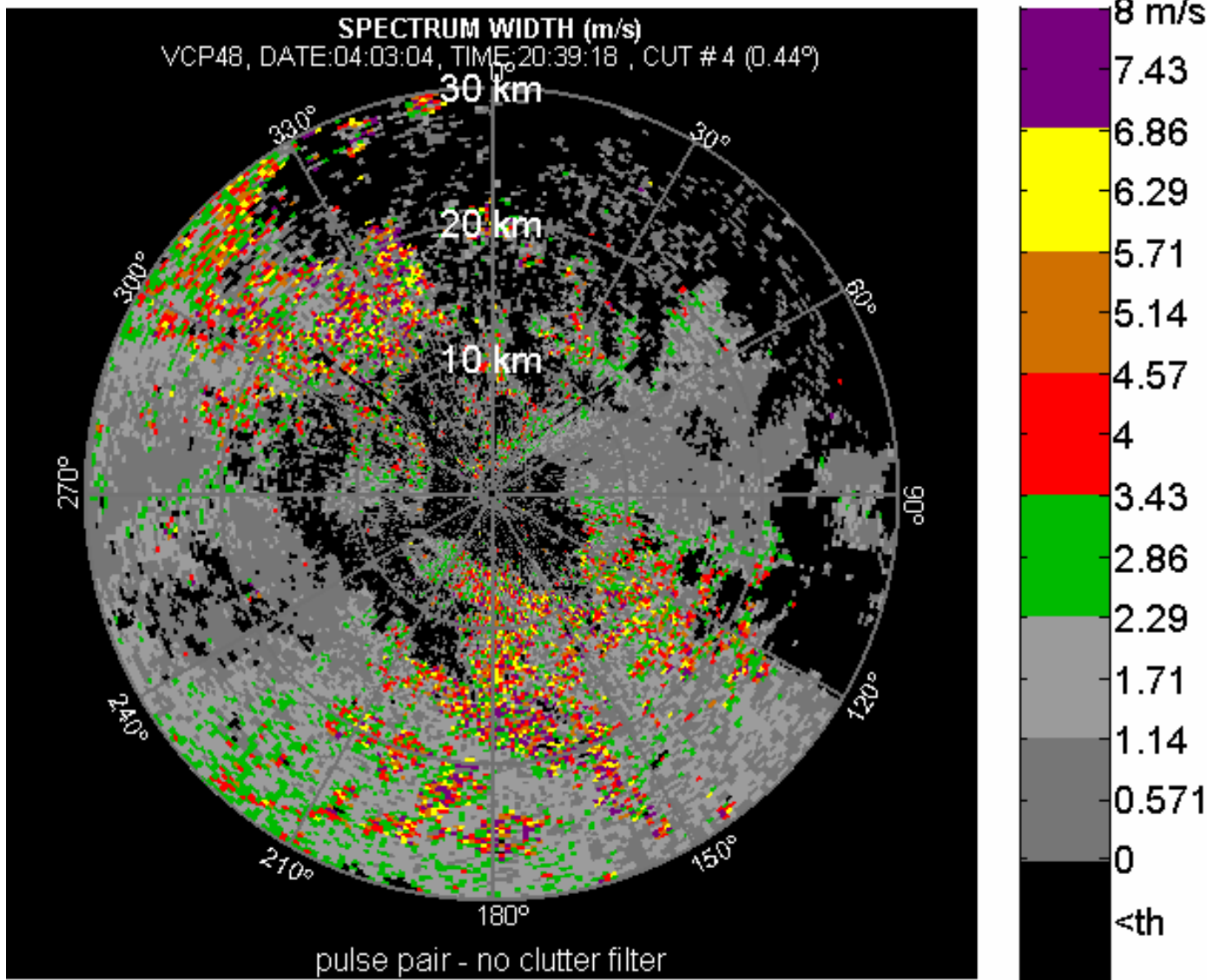

Spectrum Width after GCF (Stag. PRT)

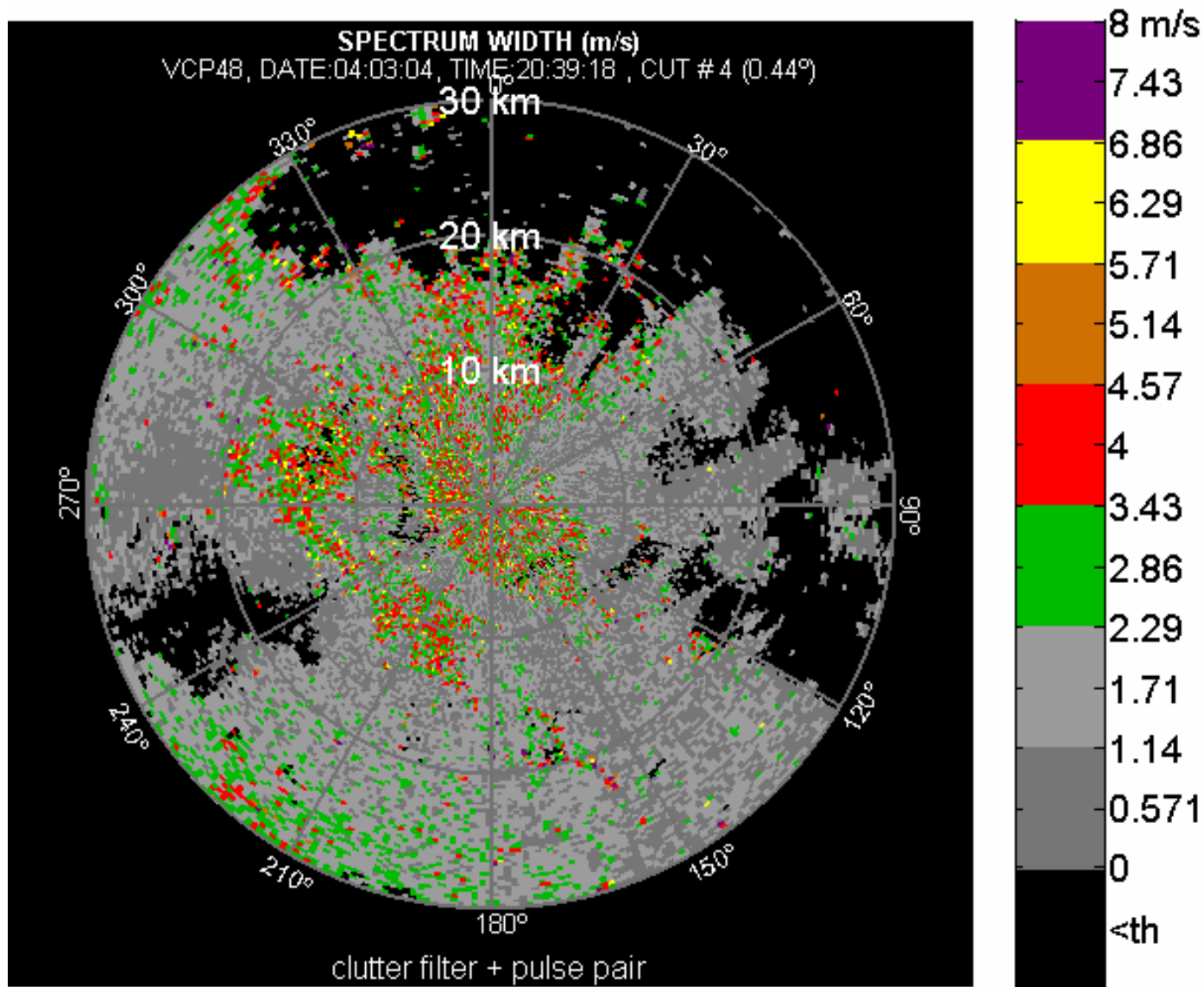

Differential Reflectivity no GCF

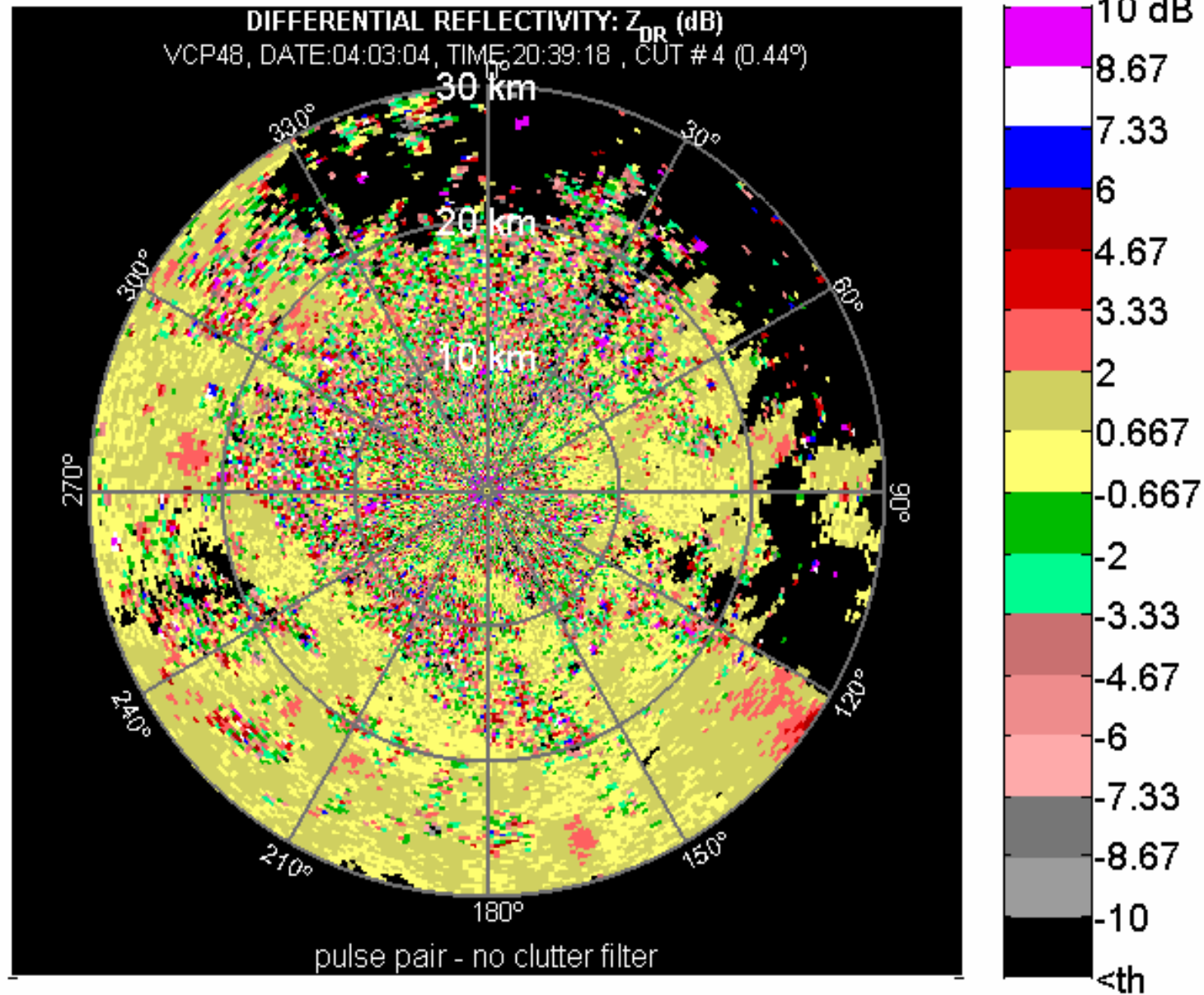

Z_{DR} after GCF (Stag. PRT)

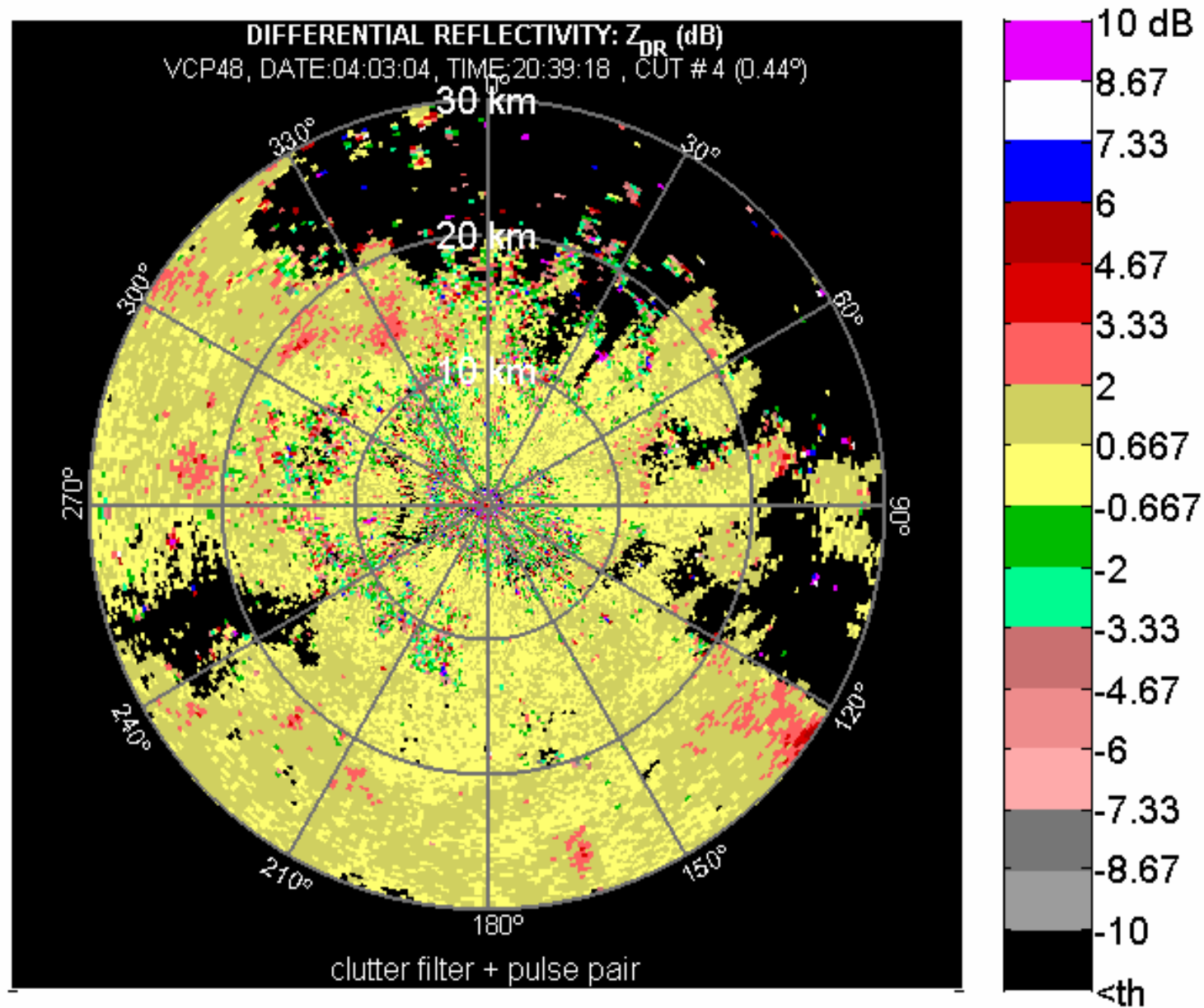

Differential Phase no GCF (St. PRT

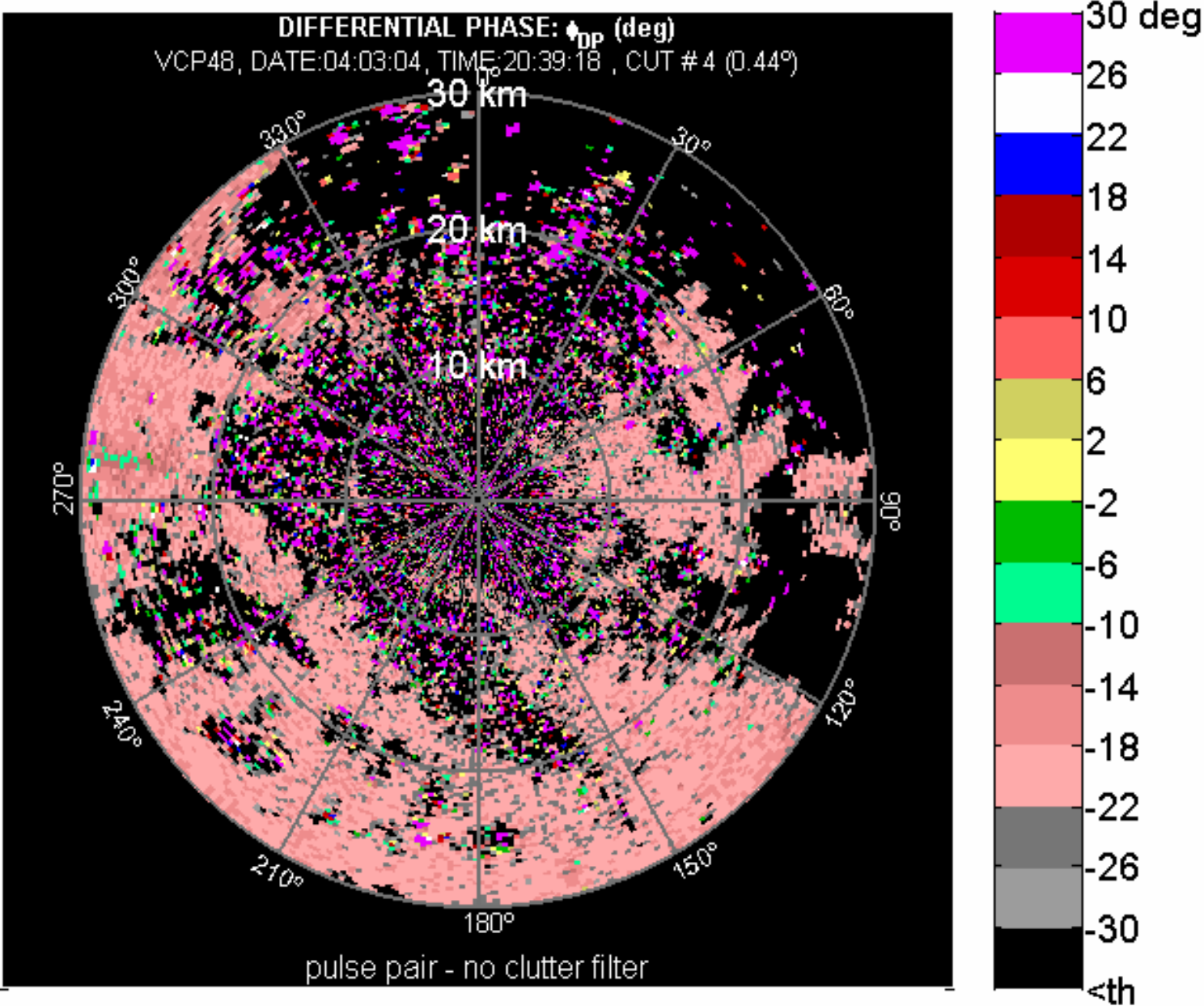

Φ_{DP} after GCF (Stag. PRT)

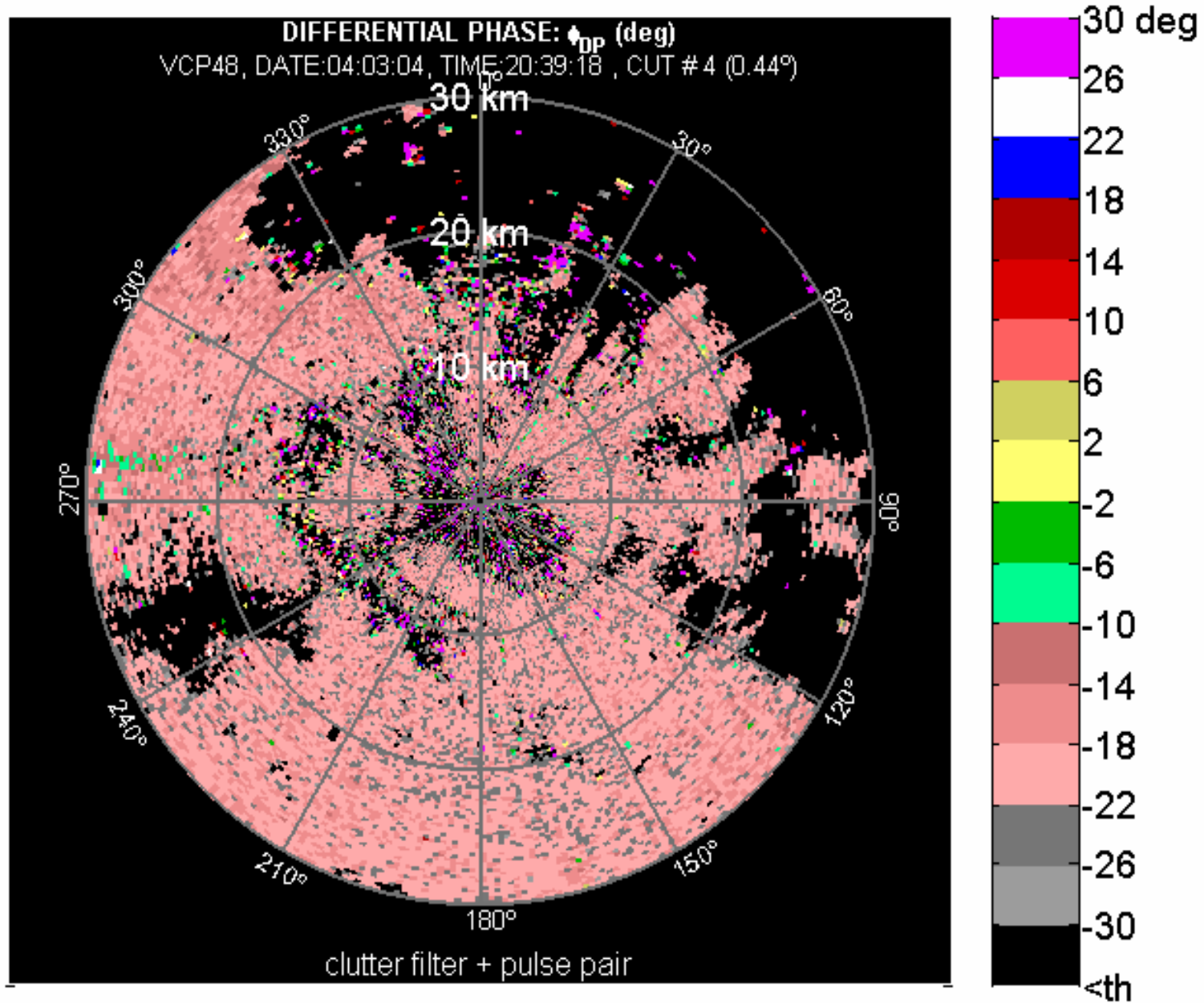

Correlation ρ_{hv} no GCF (Stag. PRT)

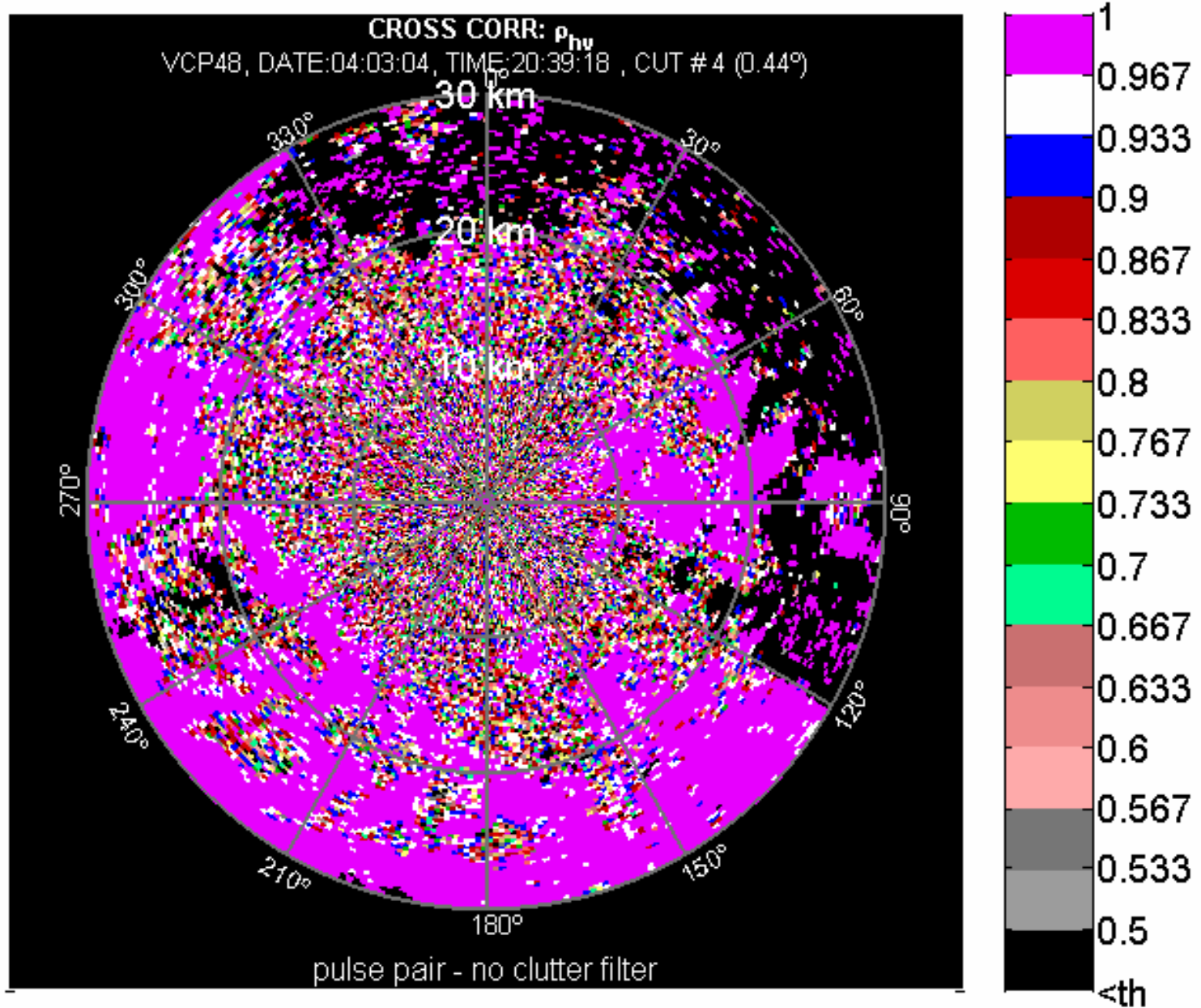

ρ_{hv} after GCF (Stag. PRT)

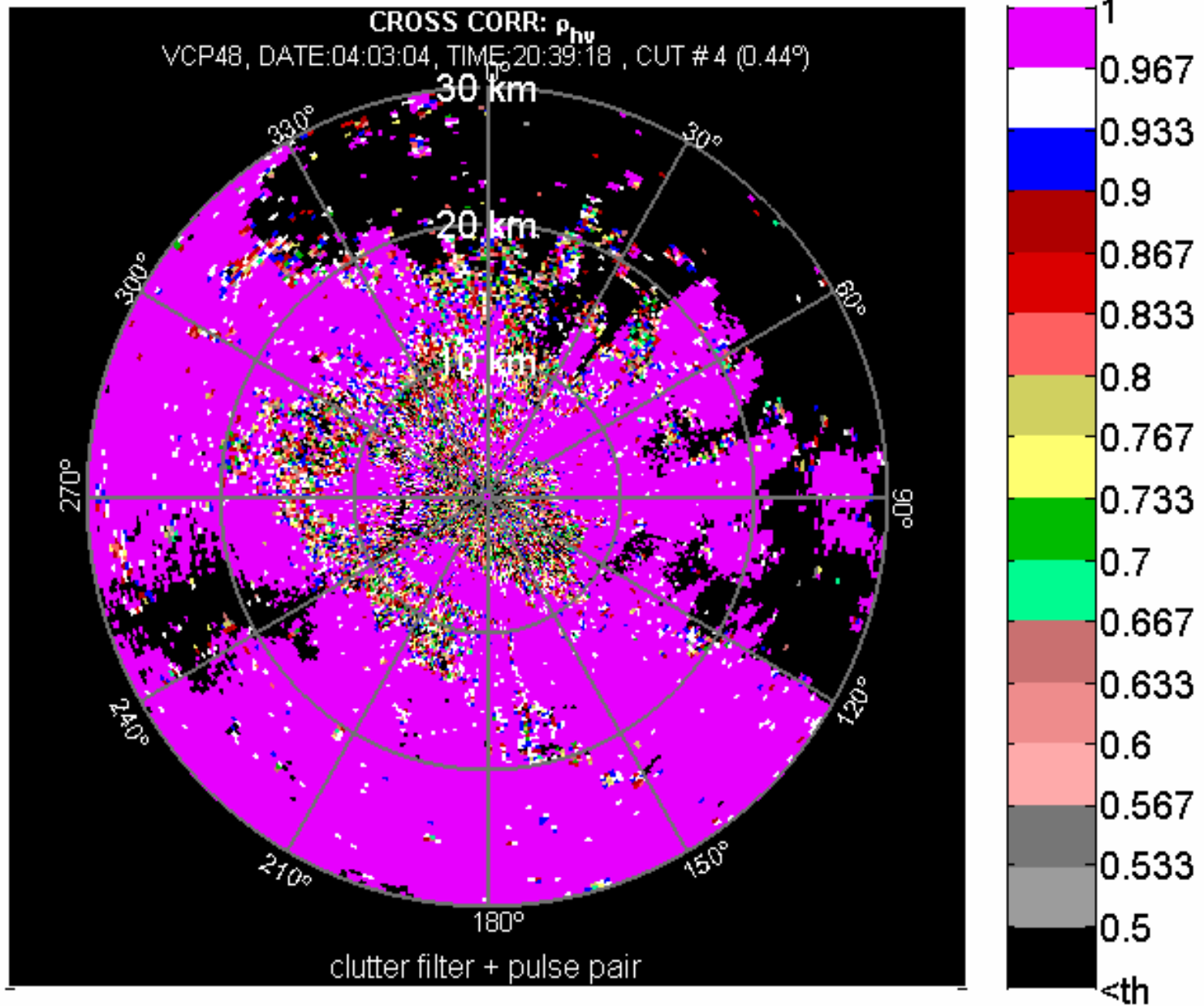

Receiver Sensitivity in the dual polarization WSR-88D

Signal to Noise Ratio - SNR

Dual pol SNR $\sim P/(2N)$
Single pol SNR $\sim P/N$

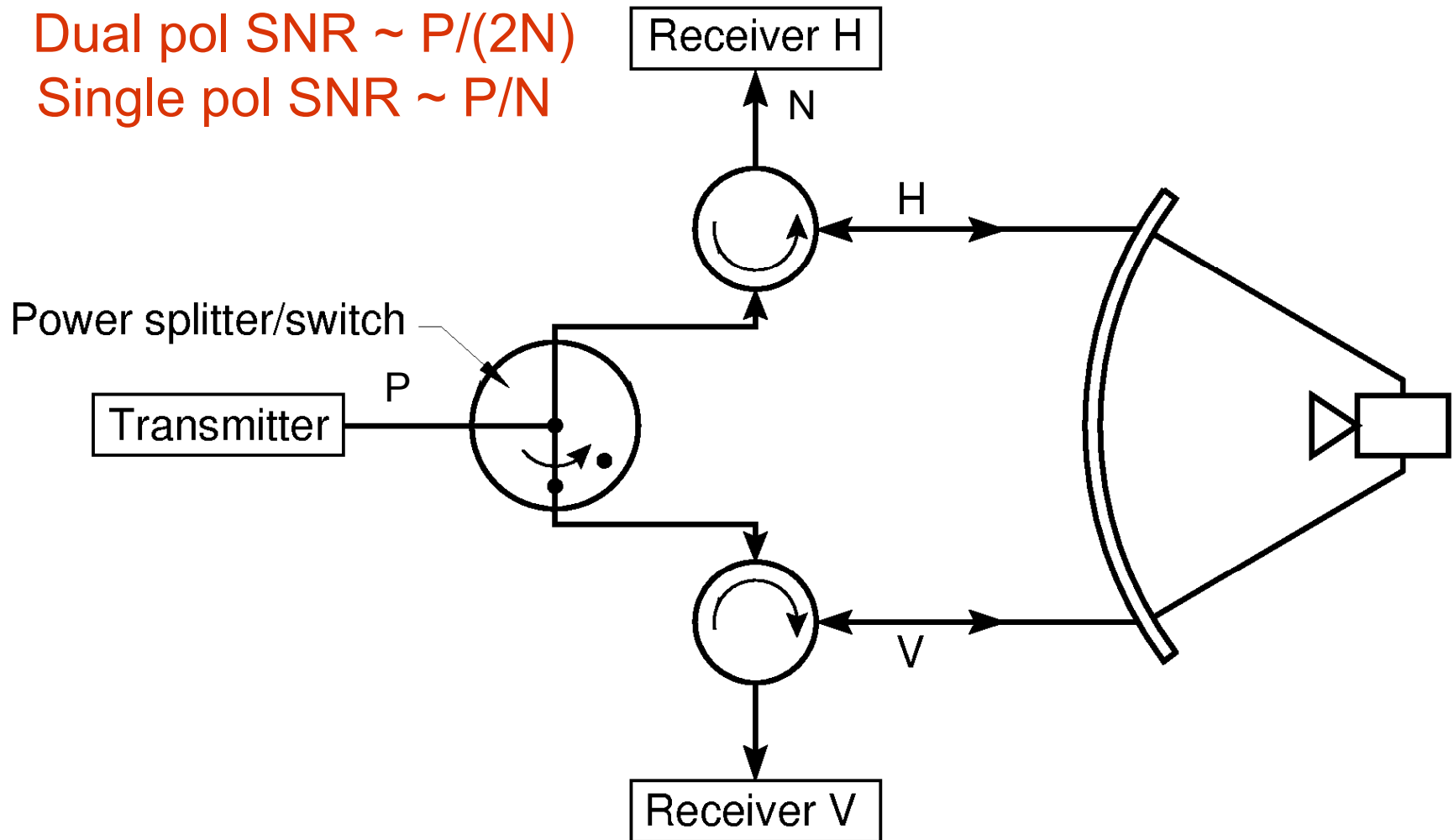

Effects of the 3 dB loss

- Increased errors in estimates of reflectivity, velocity, and spectrum width
- More data are below the SNR threshold and thus could be lost
- On the current WSR-88D (Legacy)
 - SNR threshold for velocity is 3.5 dB
 - SNR threshold for reflectivity is 2 dB
$$10\log(P-N) > 10\log(N) + 2 \text{ dB}$$

Recommendation

- Use thresholds on the magnitude of the autocorrelation instead of the signal power on Z , v and σ_v
- Combine the autocorrelations (pulse pair) from the two channels (Horizontal and Vertical) to obtain estimates of v and σ_v

Recommendation

-For velocity and spectrum width estimates sum the two autocovariances:

$$v = v_a \arg\{R_h(T)+R_v(T)\}/\pi$$

and use the following thresholds

for $0.5 \text{ dB} < \text{SNR} < 3.5 \text{ dB}$ take data which has

$$|R_h(T)+R_v(T)|/2 > T_a = 0.25 N$$

for $\text{SNR} > 3.5 \text{ dB}$ take all the data

-For reflectivity estimates use the following thresholds

for $-1 \text{ dB} < \text{SNR} < 2 \text{ dB}$ take data which has

$$|R_h(T)+R_v(T)|/2 > T_a = 0.5 N$$

for $\text{SNR} > 2 \text{ dB}$ take all the data

Choose T_a which produces acceptable probability of false alarm, similar to the current Legacy system (i.e., with a 2 dB SNR threshold!).

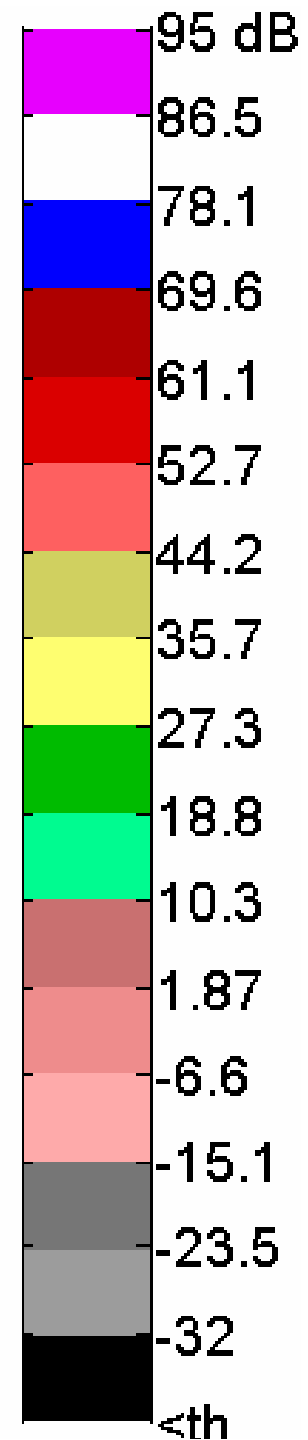
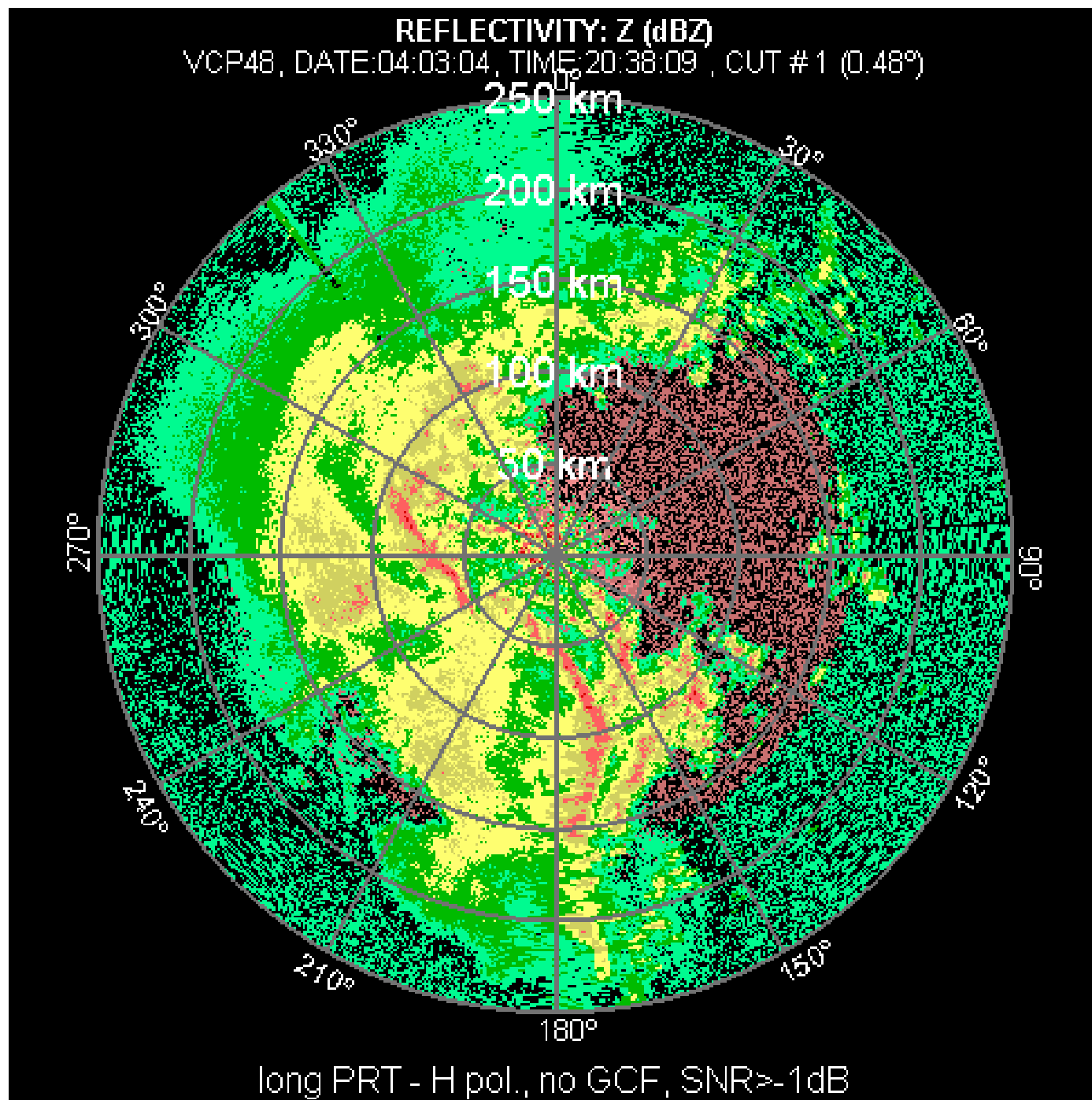

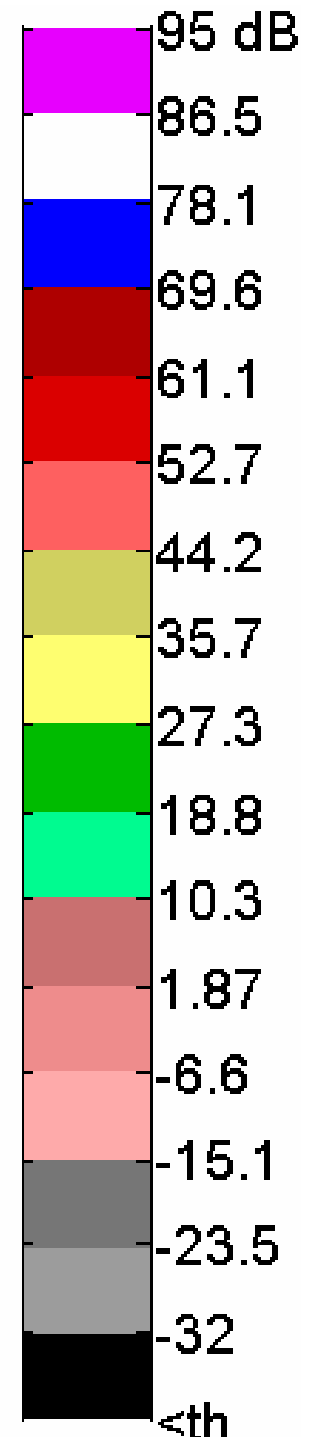
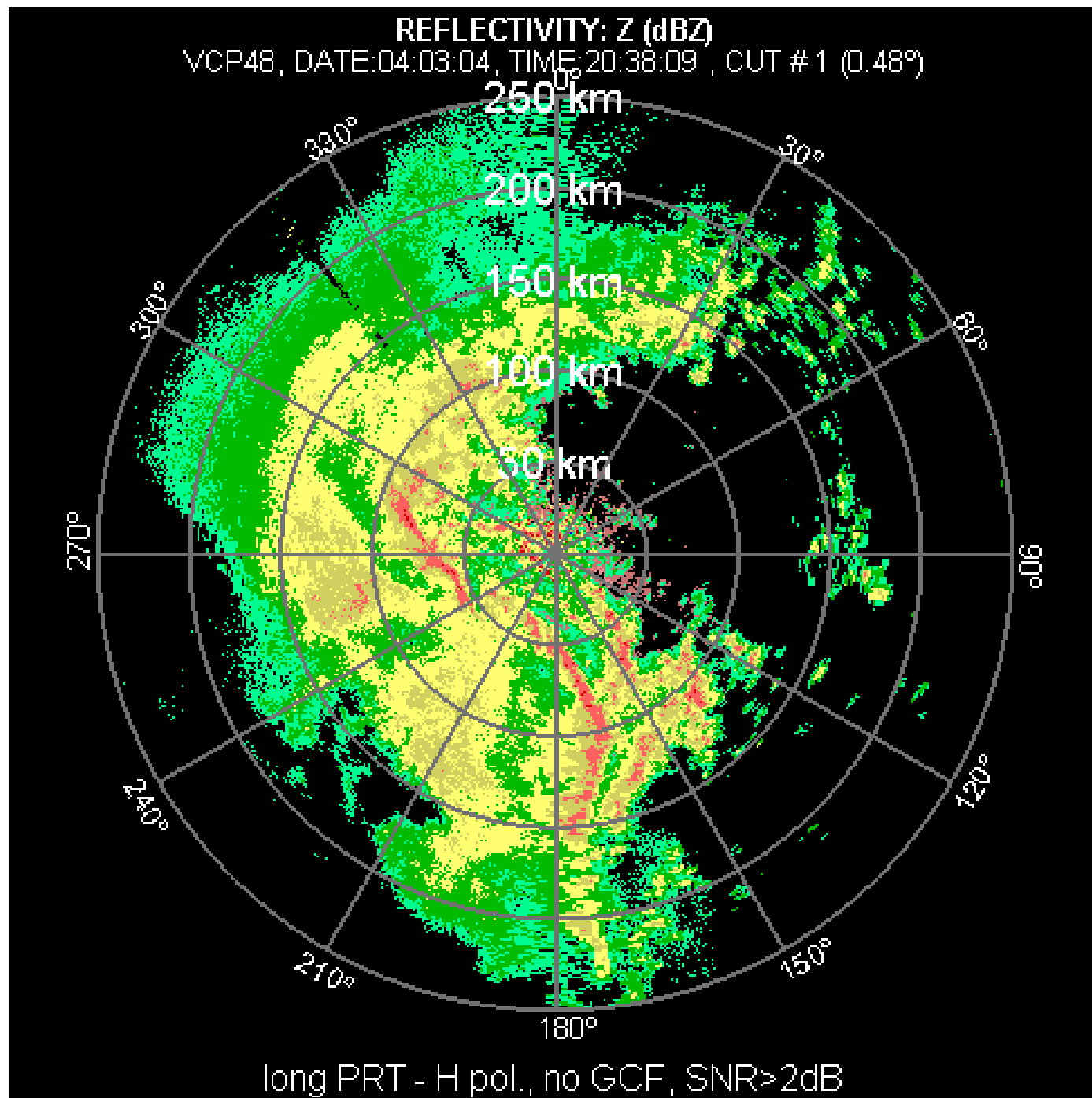

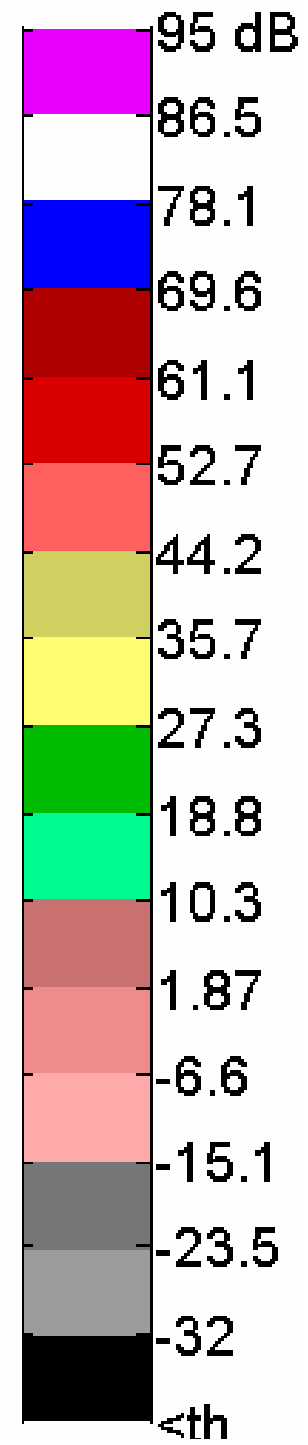
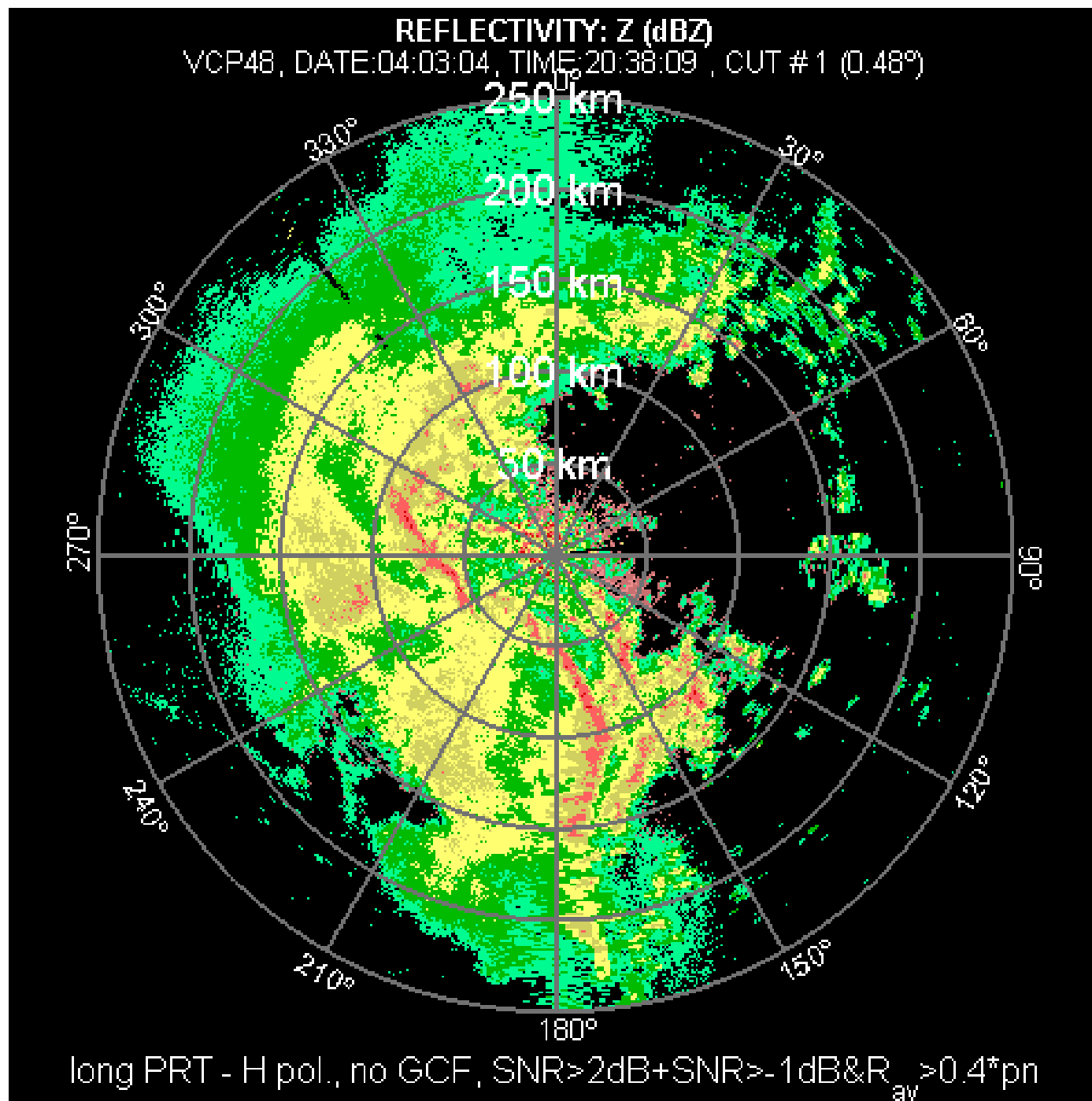

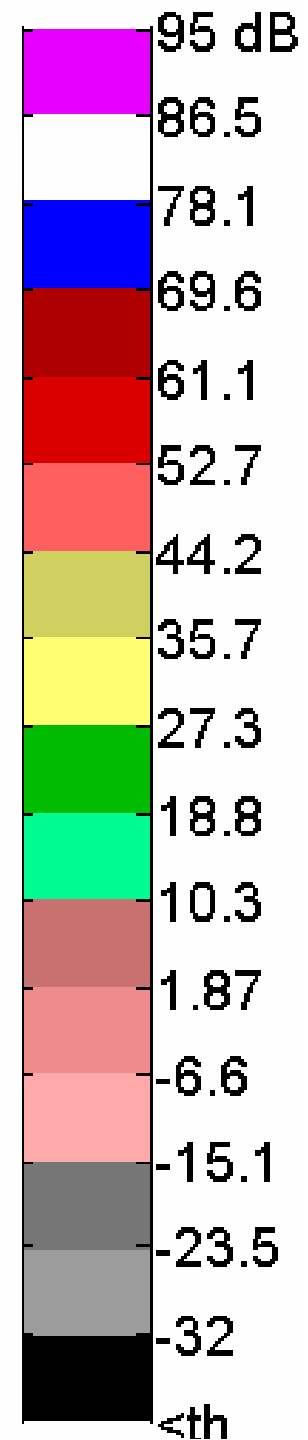
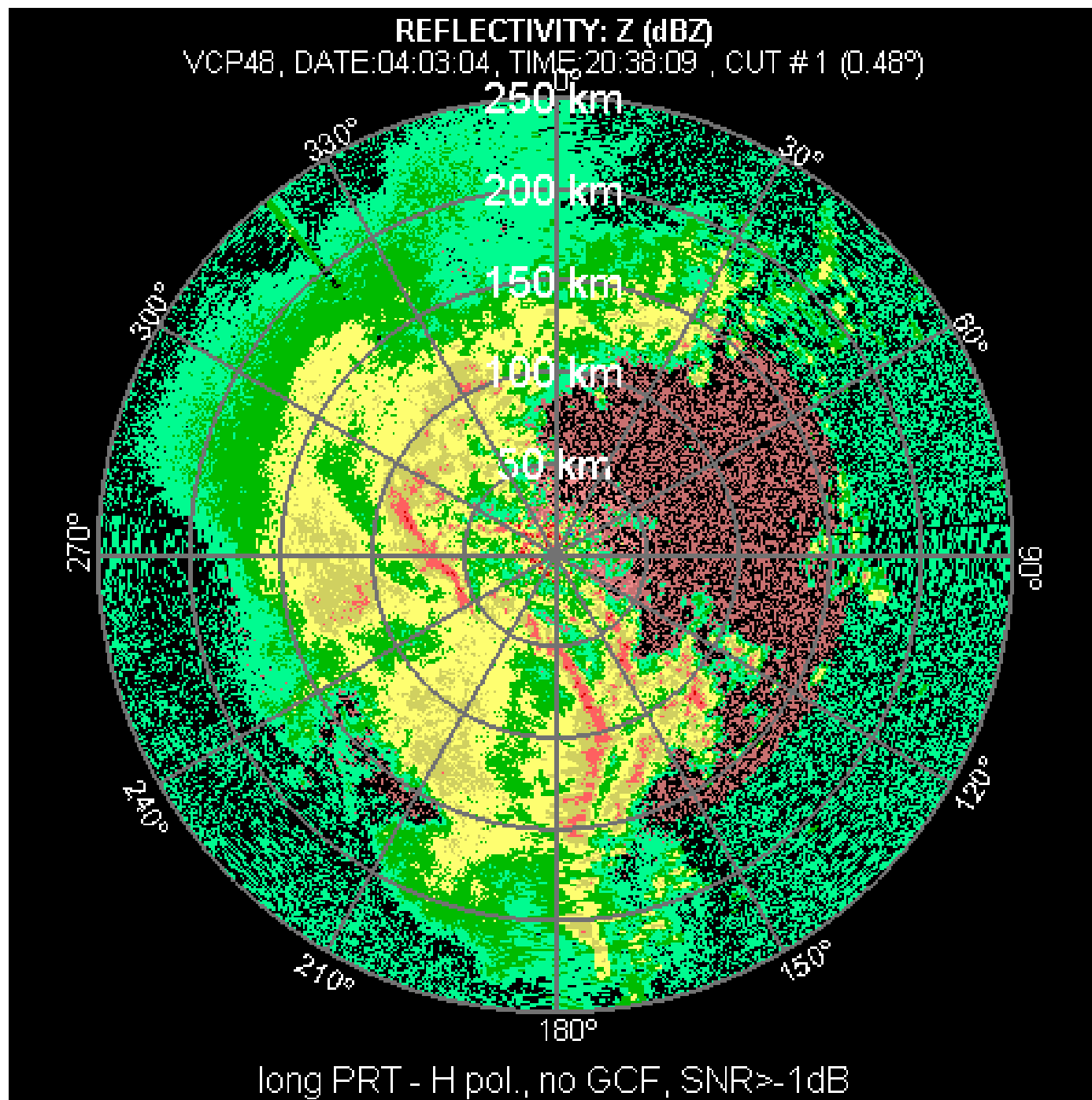

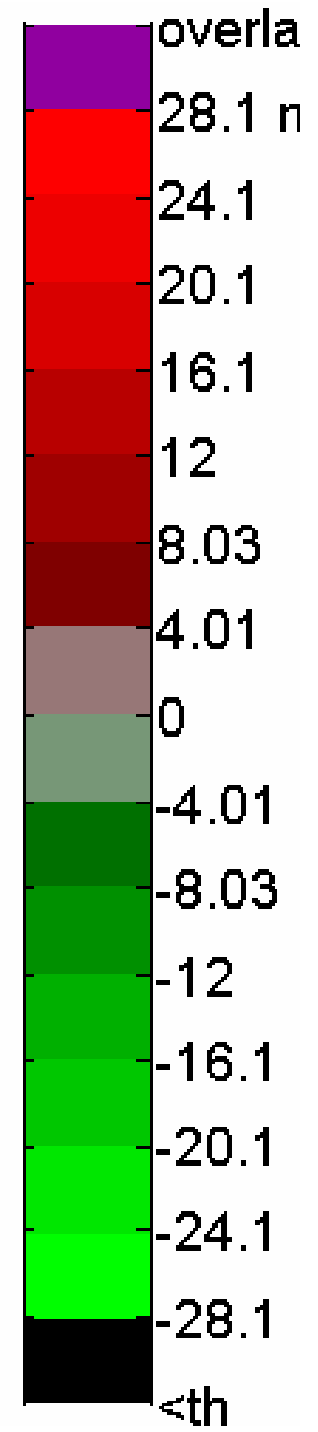
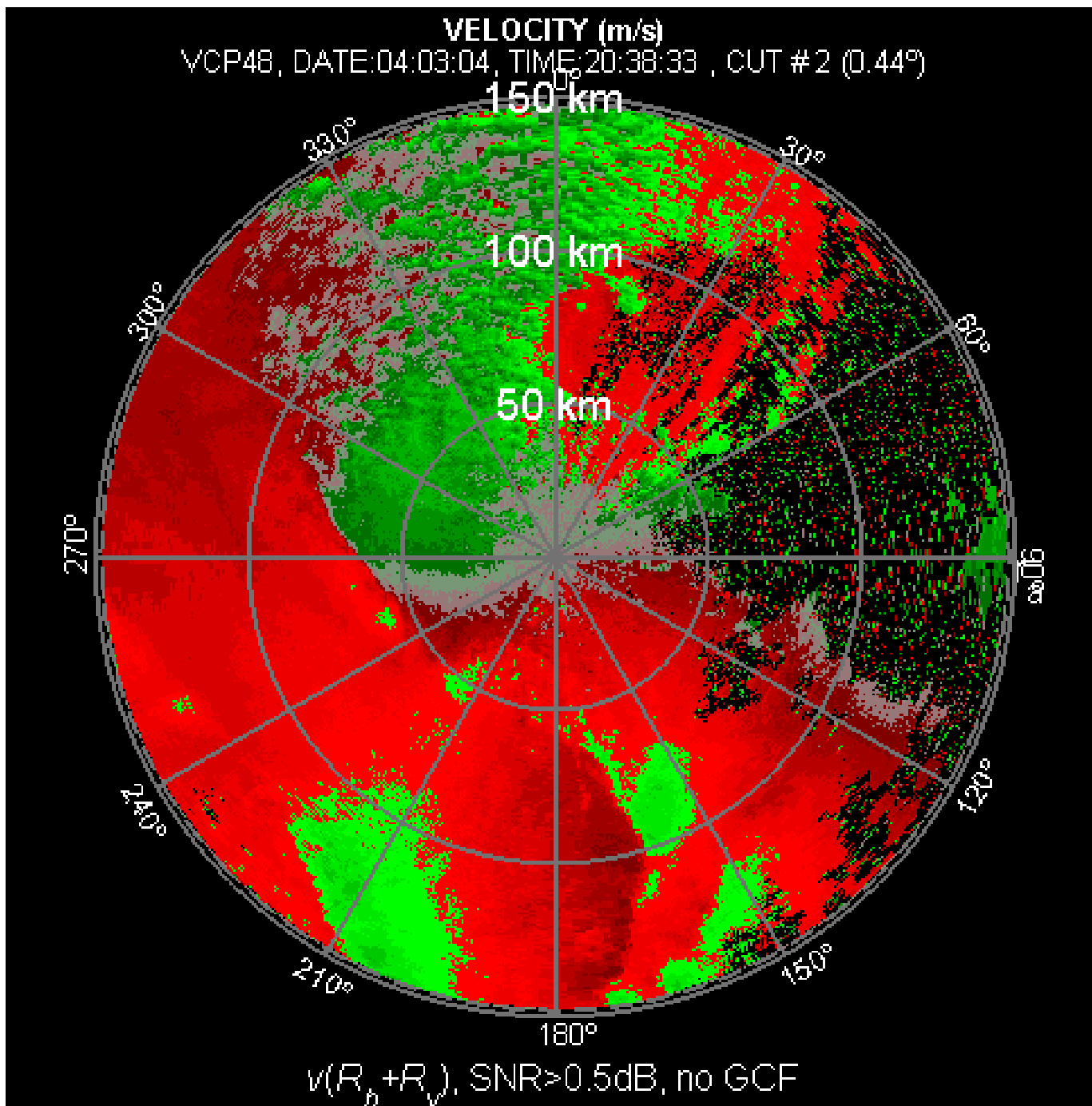

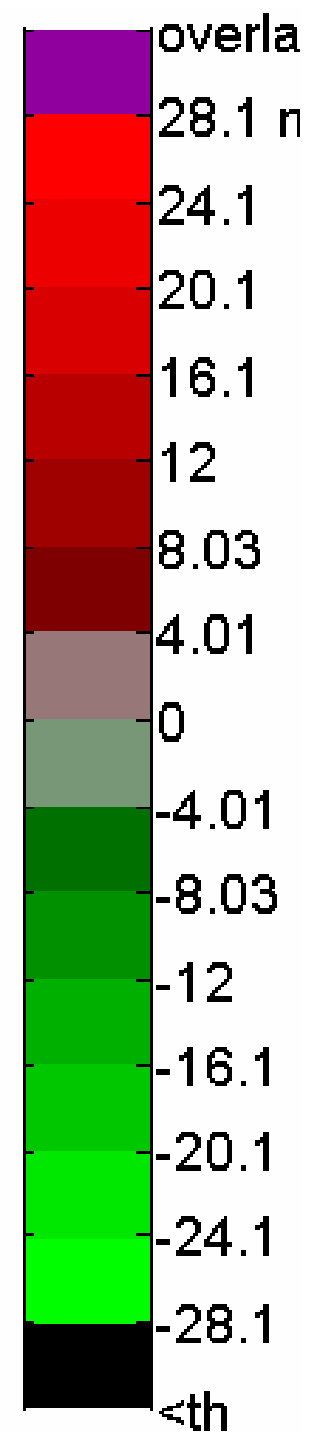
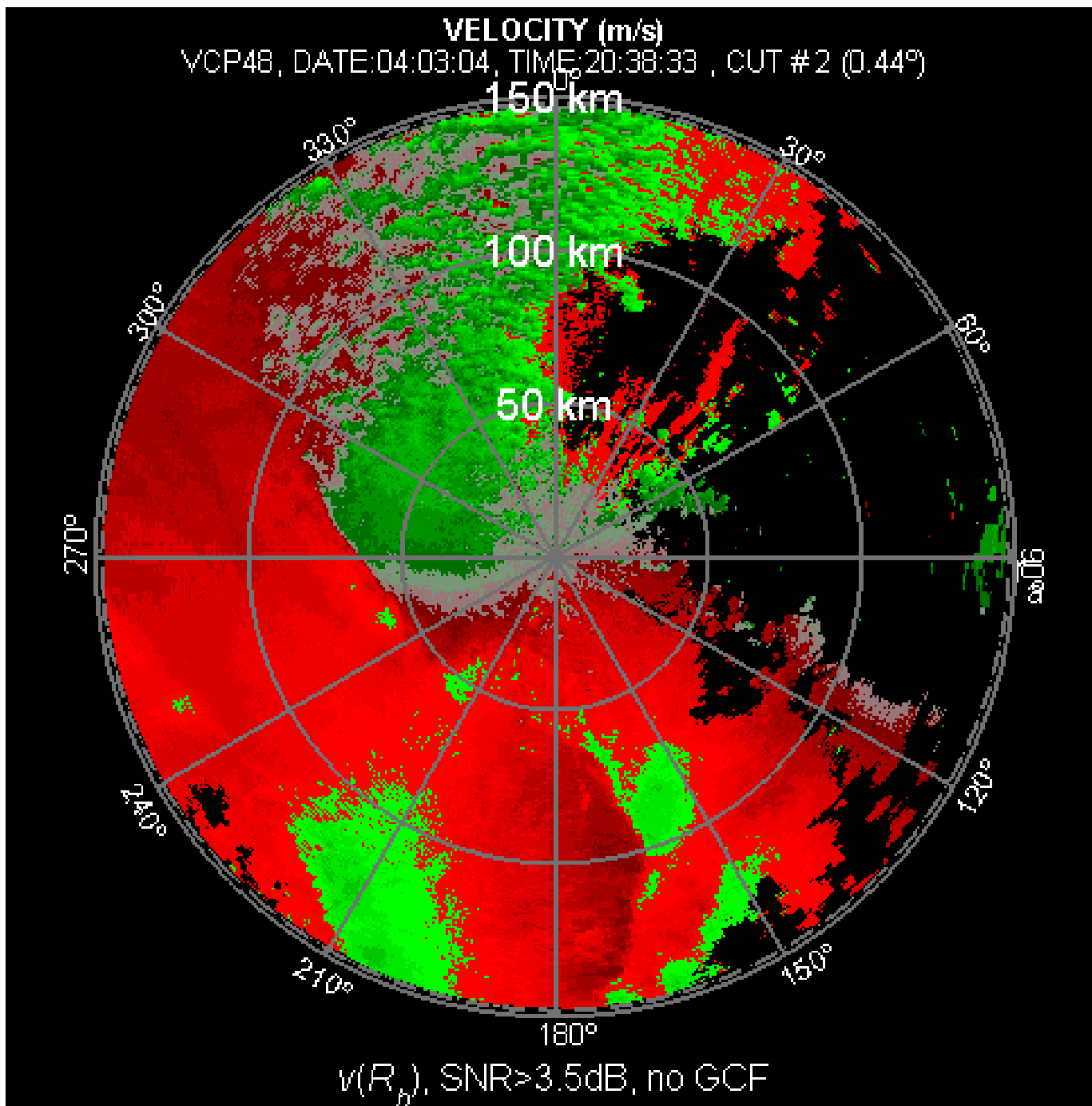

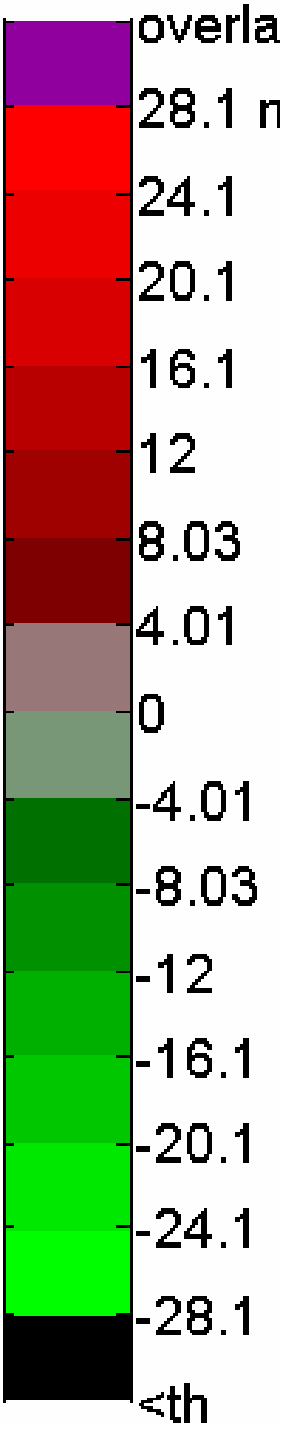
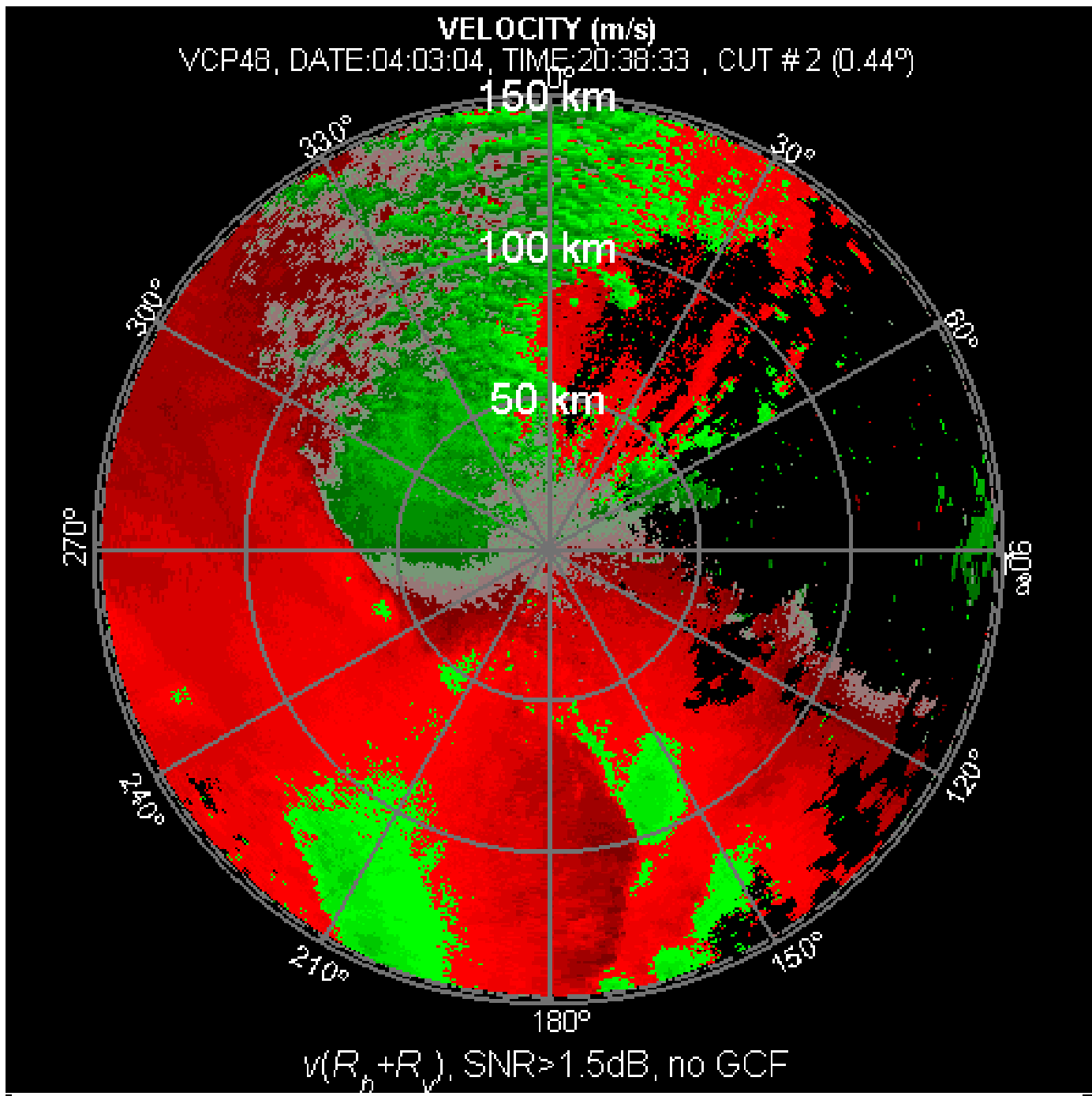

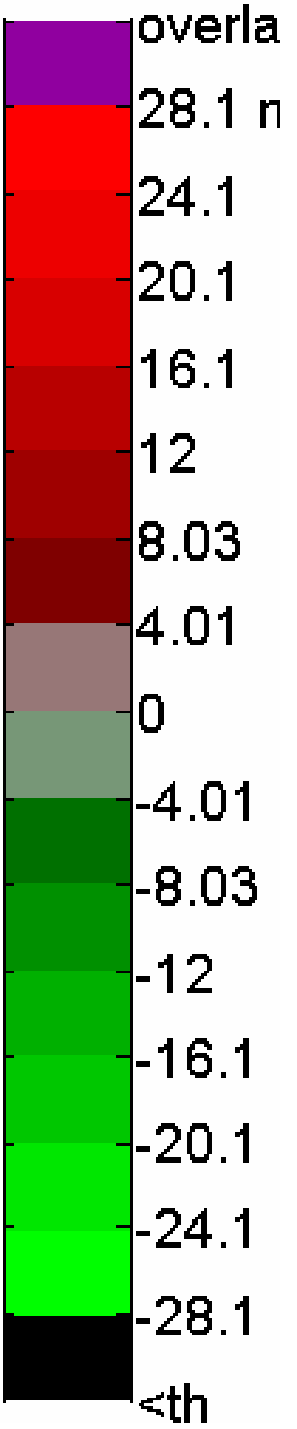
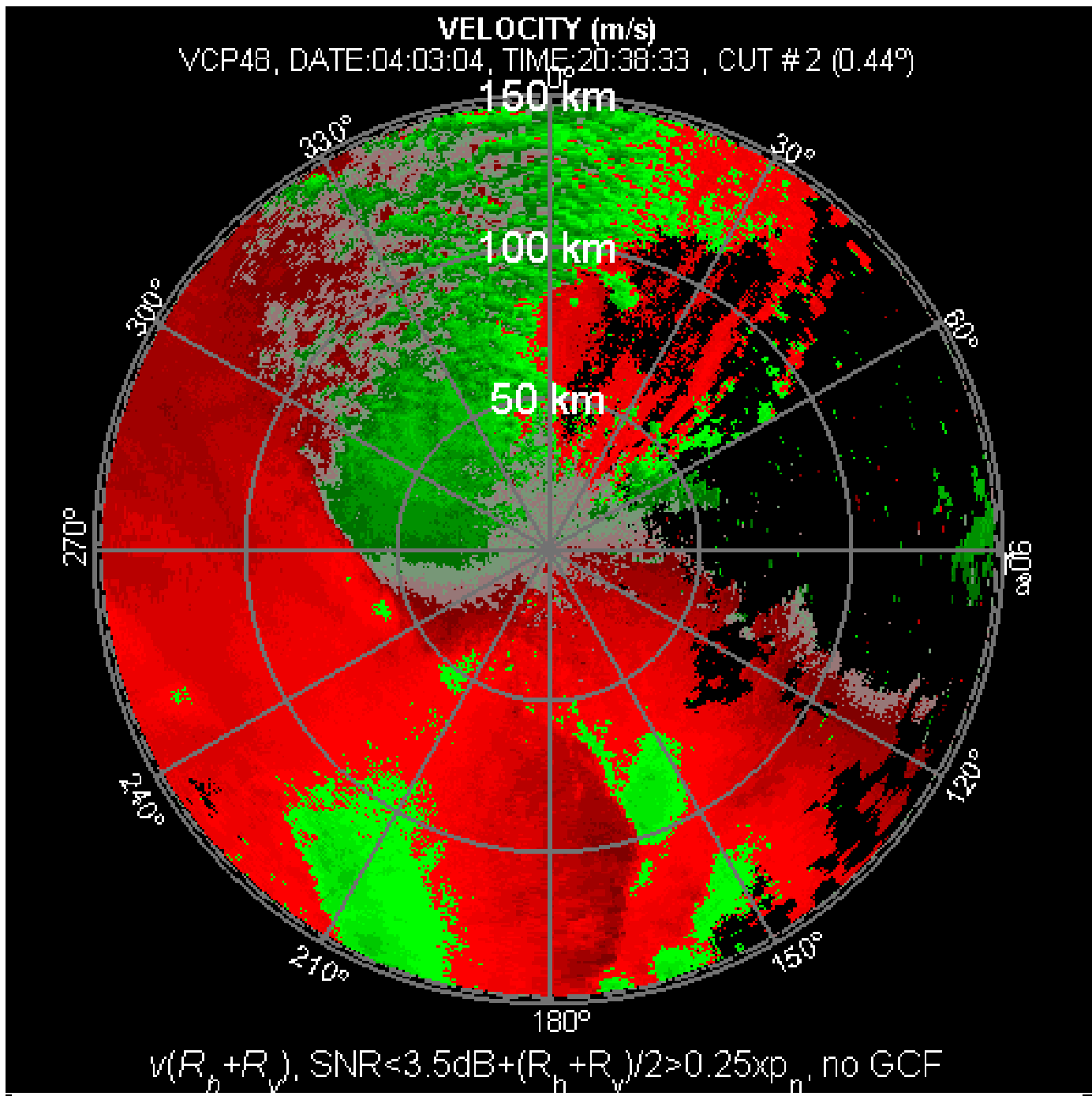

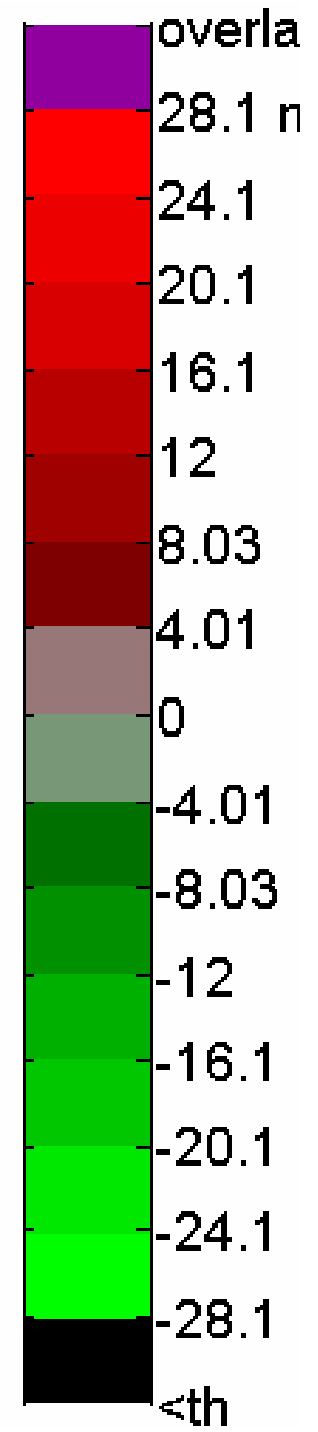
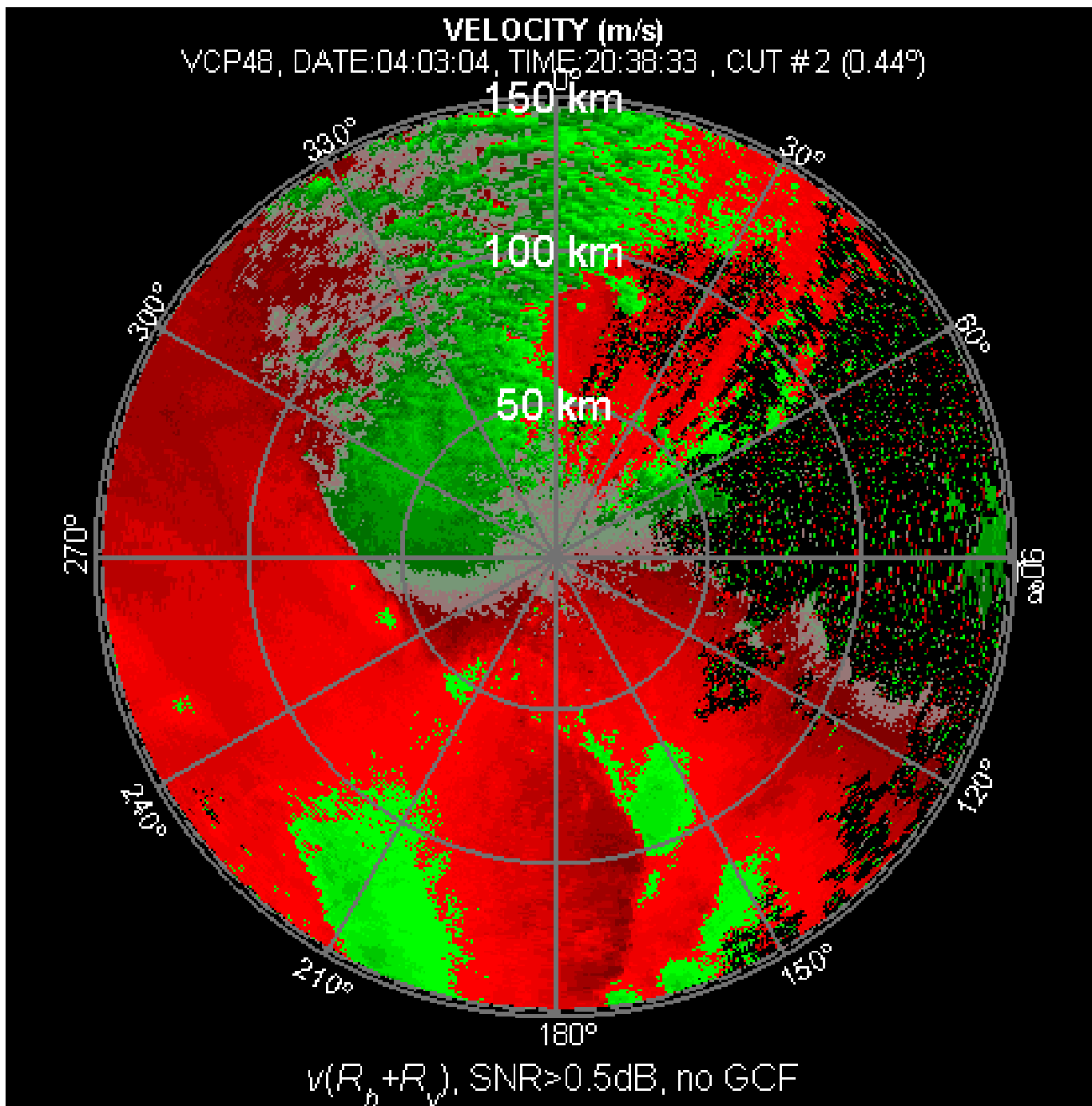

Spectral Processing of Staggered PRT

Frequency domain, DFT of the coded signal – has 5 replica

Replicas can overlap

Perfect reconstruction is possible if the replicas occupy less than $2/(5T_u)$, or 40% of extended Nyquist interval

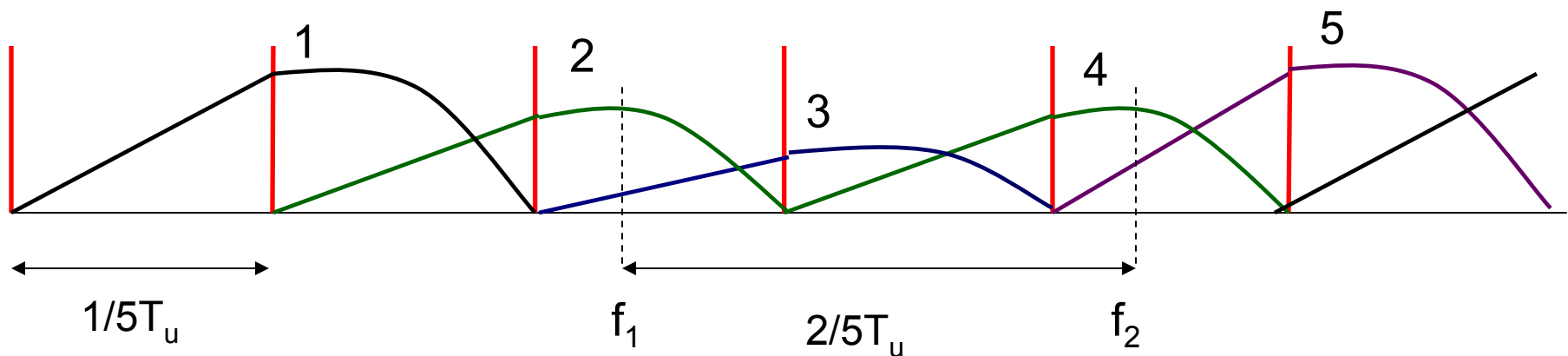

At frequencies f_1 and f_2 the computed complex spectrum coefficients are

$$V(f_1) = C(2) E(f_1,2) + C(3) E(f_1,3)$$

$E(f_1)$ is Green, $E(f_2)$ is Blue

$$V(f_2) = C(4) E(f_2,4) + C(5) E(f_2,5)$$

Solve for the two complex spectral components $E(f_1)$ and $E(f_2)$